

# SuperFlo ABS

Specification guide



## CHILLED & COLD WATER PIPEWORK

**Durapipe SuperFLO ABS for low temperature fluid transportation.**

**Durapipe SuperFLO ABS combines corrosion resistance, toughness and economic benefits to provide tremendous advantages for low temperature fluid transportation.**

SuperFLO ABS is a solvent welded, fully matched pipework system incorporating pipe, fittings and valves that is available in both imperial and metric sizes.

SuperFLO ABS provides a wide temperature range and the system remains extremely ductile even at temperatures as low as -40°C.

Furthermore, SuperFLO ABS is extremely lightweight and is much easier to handle on-site than traditional materials especially during installation which can significantly reduce both time and cost, as well as being fully WRAS approved.



### Key Product Information

- Size Range: 3/8" to 8" (*Imperial*), 16mm to 315mm (*Metric*)
- Pressure Rating: (*Imperial*) Up to 4" Class E, Up to 6" Class D, Up to 8" Class C
- Pressure Rating: (*Metric*) PN10 - 16 to 250mm, PN8 - 315mm
- Temperature Rating: -40°C to +60°C

### Key Product Features

- Lightweight
- Easy to install
- Wide temperature range
- Tough and durable
- Corrosion resistant

### Typical Applications

- Chilled water
- Boosted cold water
- Potable water
- Low temperature cooling
- Demineralised water
- Vacuum systems
- Waste water



## Index

	<i>page</i>		<i>page</i>
<b>SuperFLO ABS Overview</b> .....	<b>4-5</b>	<b>Index to ABS SuperFLO Imperial Fittings</b> .....	<b>48-73</b>
<b>Building Services Overview and Case Studies</b> .....	<b>6-7</b>	SuperFLO ABS Pipe <i>plain</i> .....	50
<b>Industrial Overview and Case Studies</b> .....	<b>8-9</b>	Sockets <i>plain</i> .....	51
<b>Sustainability</b> .....	<b>10-11</b>	Reducing bushes <i>plain</i> .....	51
<b>Technical Information</b> .....	<b>12-13</b>	Reducing sockets <i>plain</i> .....	52
Maximum pressure/temperature relationship .....	12	Elbows 45° <i>plain</i> .....	52
Fittings .....	12	Elbows 90° <i>plain</i> .....	52
Flow calculations.....	12	Tees 45° <i>plain</i> .....	53
Flow Nomogram .....	13	Tees 90° <i>equal plain</i> .....	53
<b>SuperFLO ABS Jointing Guide</b> .....	<b>14-22</b>	Tees 90° <i>swept plain</i> .....	53
Procedure .....	14	Tees 90° <i>reducing</i> .....	53
Drying times.....	15	Bends 22 <sup>1</sup> / <sub>2</sub> ° <i>long radius</i> .....	54
Branch connections.....	16	Bends 45° <i>long radius</i> .....	54
The use of bushes, reducers and threaded adaptors.....	17	Bends 90° <i>long radius</i> .....	54
SuperFLO flexible hoses.....	17	Bends 90° <i>short radius plain</i> .....	54
Threaded connections.....	18	Saddles <i>plain</i> .....	55
Tightening torques for flange bolts in ABS piping systems .....	18	End caps <i>plain</i> .....	55
Pipe routing .....	19	Socket unions <i>plain</i> .....	55
Calculating expansion and contraction.....	19	Imperial/metric socket adaptors <i>plain</i> .....	56
<b>Additional Important Information</b> .....	<b>23</b>	Sockets <i>plain female BSP thread</i> .....	56
<b>Comparison of SuperFLO ABS Imperial and Metric Sized Pipe</b> .....	<b>24</b>	Reducing bushes <i>plain female BSP thread</i> .....	56
<b>General Information</b> .....	<b>25-27</b>	Elbows 90° <i>plain female BSP thread</i> .....	57
<b>Index to SuperFLO ABS Metric Fittings</b> .....	<b>28-47</b>	Female threaded adaptors <i>plain spigot end/female BSP thread</i> .....	57
SuperFLO ABS Pipe <i>plain</i> .....	30	Hexagon nipples <i>plain spigot/male BSP thread</i> .....	57
Sockets <i>plain</i> .....	30	Male threaded adaptors <i>plain/male BSP taper threaded</i> .....	58
Reducing bushes <i>plain</i> .....	31	Barrel nipples <i>plain/BSP taper threaded</i> .....	58
Reducing sockets <i>plain</i> .....	31	Hose adaptors <i>BSP taper threaded/hose tail</i> .....	58
Elbows 45° <i>plain</i> .....	31	Tank connectors <i>plain spigot/male BSP parallel thread</i> .....	59
Elbows 90° <i>plain</i> .....	32	Composite unions <i>plain/brass, female BSP parallel thread</i> .....	59
Tees 45° <i>plain</i> .....	32	Composite unions <i>plain/brass, male BSP taper thread</i> .....	59
Tees 90° <i>equal</i> .....	32	Composite unions <i>plain/stainless steel, female BSP parallel thread</i> .....	60
Tees 90° <i>swept plain</i> .....	33	Composite unions <i>plain/stainless steel, male BSP parallel thread</i> .....	60
Tees 90° <i>reducing plain</i> .....	33	Sockets <i>female BSP taper thread</i> .....	60
Bends 90° <i>short radius</i> .....	33	Reducing bushes <i>male/female BSP thread</i> .....	61
Bends 90° <i>long radius</i> .....	34	Elbows 90° <i>female BSP taper thread</i> .....	61
End caps <i>plain</i> .....	34	End caps <i>female BSP taper thread</i> .....	61
Socket unions <i>plain</i> .....	34	Plugs <i>male BSP taper thread</i> .....	62
Imperial/metric socket adaptors <i>plain</i> .....	35	Hexagon nipples <i>male BSP taper thread</i> .....	62
Male threaded adaptors <i>BSP taper male thread</i> .....	35	Back nuts <i>female BSP taper thread</i> .....	62
Female threaded adaptors <i>plain spigot/plain socket/female BSP thread</i> .....	35	Flanges stub <i>plain/serrated</i> .....	62
Hose adaptors <i>spigot end/hose tail</i> .....	36	Flanges full face <i>plain/drilled</i> .....	63
Female composite unions <i>plain/brass, female BSP parallel thread</i> .....	36	Flanges blanking <i>plain/drilled</i> .....	64
Male composite unions <i>plain/brass, male BSP taper thread</i> .....	36	Backing rings <i>galvanised mild steel drilled</i> .....	65
Female composite unions <i>plain/stainless steel, female BSP parallel thread</i> .....	37	Gaskets flat stub <i>flange EPDM</i> .....	66
Male composite unions <i>plain/stainless steel, male BSP parallel thread</i> .....	37	Gaskets full face <i>drilled EPDM</i> .....	66
Flexible hoses <i>plain spigot, BSP thread</i> .....	38	Valve support plates <i>galvanised mild steel</i> .....	67
Wall brackets <i>ABS/brass body</i> .....	38	O-Rings .....	67
Flanges stub <i>plain serrated</i> .....	39	<b>Valves</b>	
Flanges blanking.....	39	VKD Double union ball valves .....	68
Backing rings <i>galvanised mild steel</i> .....	40	TKD 3-way ball valves.....	68
Flat gaskets for use with stub flanges.....	41	VXE Easyfit double union ball valves .....	69
Valve support plates <i>galvanised steel</i> .....	41	VKR Metering ball valves .....	69
O-Rings .....	41	SX Easyfit ball check valves .....	69
<b>Valves</b>		SA Easyfit air release valves .....	70
VKD Double union ball valves .....	42	RV Y-Type strainers.....	70
TKD 3-way ball valves.....	42	Dialock Diaphragm valves.....	70
VXE Easyfit double union ball valves .....	43	Pressure Loading/Relief valves.....	71
VKR Metering ball valves .....	43	FK Butterfly valves .....	71
SX Easyfit ball check valves .....	43	<b>Accessories</b>	
SA Easyfit air release valves .....	43	One-step solvent cement.....	72
RV Y-Type strainers.....	44	Eco-cleaner .....	72
Dialock Diaphragm valves.....	44	Cobra pipe clips.....	72
Pressure Loading/Relief valves.....	44	Saddle clips .....	72
FK Butterfly valves .....	45	Chamfering and de-burring tools.....	73
<b>Accessories</b>		Pipe cutters.....	73
Cobra pipe clips.....	46	Fibreseal .....	73
Rubber lined pipe clips.....	46	<b>Product Specification (Metric)</b> .....	<b>74</b>
One-step solvent cement.....	46	<b>Product Specification (Imperial)</b> .....	<b>75</b>
Eco-cleaner .....	47	<b>Company History</b> .....	<b>76</b>
Chamfering and de-burring tools.....	47	<b>Actuated Valves</b> .....	<b>77</b>
Pipe cutters.....	47	<b>Durapipe UK Pipework Systems</b> .....	<b>78</b>
Fibreseal .....	47	<b>Conditions of Sale</b> .....	<b>79</b>

## What is SuperFLO ABS?

SuperFLO ABS combines numerous performance and economic benefits which make it the ideal solution when there is a requirement for a pipe system to transport low temperature fluids at pressure. SuperFLO ABS is a copolymer of Acrylonitrile Butadiene Styrene, blended, to give unrivalled properties and benefits over traditional pipework materials such as copper or steel.

Acrylonitrile imparts chemical resistance ensuring the pipework does not corrode or scale. The Butadiene content endows the material with impact strength and toughness, particularly at low temperatures, while the Styrene content contributes to lustre, hence the extremely smooth bores, and also ensures the strength of the material.



## Tough and Durable

The Butadiene element of SuperFLO ABS affords exceptional resistance to accidental damage, even at sub-zero temperatures. SuperFLO ABS is therefore extremely ductile and performs at temperatures as low as minus 40°C.



Copper pipe vs ABS pipe

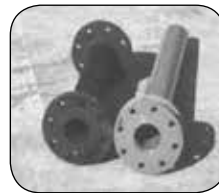

Copper vs ABS



Steel pipe



Plastic pipe

## Corrosion and Limescale Resistant

Both limescale and corrosion can become a problematic feature of any metal-based pipework system. However, the smooth bore lining of SuperFLO ABS pipework prohibits any limescale build-up throughout the life of the system, maintaining consistent flow rates.

Furthermore, SuperFLO ABS is extremely corrosion resistant even with a range of moderate chemicals which can mean less maintenance costs and no costly system replacement.

## Superior Flow

Low fluid friction allows higher flow velocities than metal pipes and also inhibits the formation of scale, with consequent savings in pump energy consumption, and reduced pressure drops.

## Lightweight

Durapipe SuperFLO ABS is approximately one-sixth of the weight of steel pipework. Therefore, Durapipe SuperFLO ABS is much easier to handle, especially during installation on-site.



## Wide Temperature Range

A major advantage of SuperFLO ABS over other plastic pipework systems is its ability to perform over a wide temperature range from -40°C to +60°C.

(Note: usual precautions must be taken to prevent contents freezing).

## Reduced Installation Costs

Due to the ease of jointing & installation, the lightweight nature of SuperFLO ABS and the fact that no special tools or hot works permits are required, pipework installation time is reduced considerably.

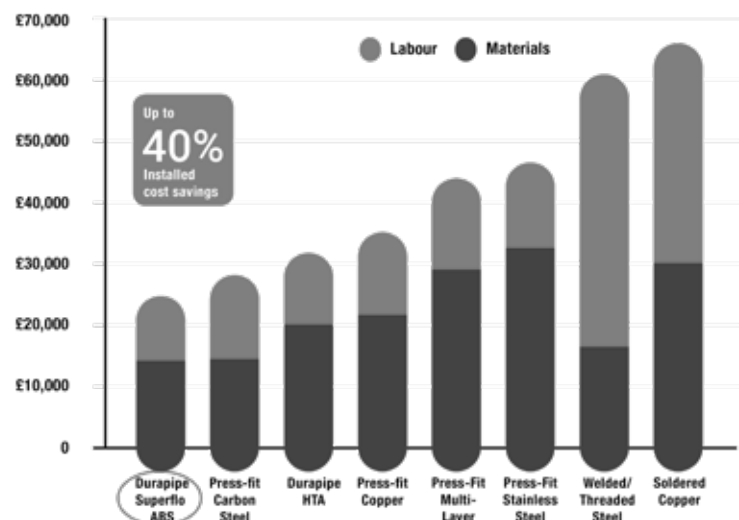

### Unrivalled Third Party Standards and Approvals

SuperFLO ABS is manufactured to the highest level and meets with the requirements of many international standards and approvals.

SuperFLO ABS has a 50 year design life with a residual safety factor of 2:1. (For full details refer to 'Design Life' section on page 74).

This unrivalled level of third party approvals offers total assurance to the designer, installer and end user that SuperFLO ABS is a consistent and reliable pipework system.

Approved for use within public water supplies and by the Secretary of State. Durapipe ABS is listed in the "List of Approved Products" published by the DWI.

\*Applies to Durapipe pipes and fittings - inch series only

### Company Chemist

Our internal company chemist is at your disposal. If you have concerns regarding the chemical combination that a pipework system needs to convey, we can evaluate suitability of the chemical you wish to convey and advise on the best material to use for the system.



### Quality Manufacturing

Quality is central to the operation with BS EN ISO 9001 certification and within an environmental management system which operates in accordance with the requirements of ISO14001.

### Global Distribution Network

SuperFLO ABS is available from an extensive international network of distributors and stockists. Please visit [www.durapipe.co.uk/resources/stockists](http://www.durapipe.co.uk/resources/stockists) for details of your nearest stockist.



### Fast, Simple and High Integrity Jointing

Solvent welding is a simple process which produces a permanent joint of strength equal to, or exceeding, the pipe itself.

- No electricity required
- No flame or combustible gas bottles required on-site
- No site downtime due to electricity shut down
- No hot works permits or need for site segregation
- Permanent, secure jointing
- No special tools needed
- Easy transition to other systems
- Reduced installation time
- Reduced installation costs
- Light and easy to handle



### Technical Support

We offer an unrivalled level of technical support where our experienced team can provide product training and installation advice on any given project. We will also provide material take-off advice if architects' drawings are supplied.



### Abrasion Resistance

SuperFLO ABS offers good resistance to abrasion and erosion from aggressive slurries.

### No Metallic Stabilisers

SuperFLO ABS does not contain any harmful metallic stabilisers, and is widely used to convey high purity deionised water in semi-conductor and pharmaceutical applications.

### Non-Toxic

Materials used are selected for their toxicological properties, and suitability for conveying cold potable water.

## Pump Efficiencies

The smooth bore of ABS pipe creates less friction than a carbon steel pipe. Less friction results in lower headloss which means a lower pump duty is required, creating energy and cost savings. The Wilo-Select software from Wilo Pumps lets the designer select the right pump for the job with all the important information at hand, eg. the product description, operating instructions and specification text. The planning software from Wilo is therefore an optimal tool for HVAC experts, system technicians and planners. Wilo Select can compare the pump duty requirement using different pipe materials (plastic & steel) and can show how a lower pump duty can be selected when using plastic pipework. As well as requiring a lower cost pump, energy cost savings of 75% are achievable by using ABS compared to steel pipework.\*

*\*Cost savings based on a theoretical light commercial installation which requires 200m of straight 32mm pipe, 20x elbows and 2x isolation valves... and assuming a flow rate of 1.0 l/sec.*



## Offsite Modular Construction

Offsite modular engineering involves the creation in factory conditions of multi-service modules, containing all the services needed for a building. The benefits of offsite modular production include:

- Cuts costs by up to 15%
- Reduces time on-site from weeks to days
- Overcomes skills shortages by using less technical trades for on-site installation
- Satisfies need for sustainable construction practices
- Reduces health & safety risks on-site
- Reduces waste & environmental impact of a project

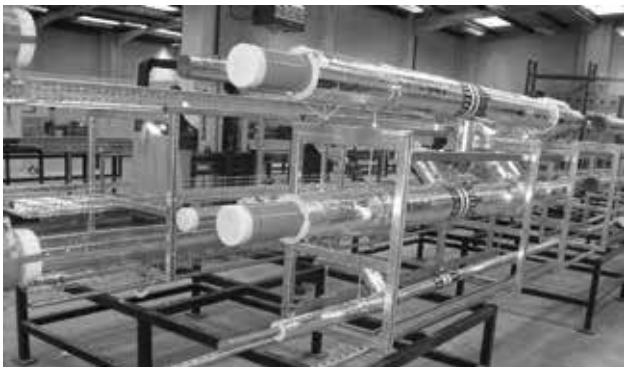

## BIM

In 2011 the UK Government published its Construction Strategy that outlined the requirement for fully collaborative 3D BIM as a mandatory public building procurement process for all buildings over £5m from 2016. The key objective is to reduce capital cost and the carbon burden from the construction and operation of the built environment by 20%. The use of BIM will provide a more efficient way of working at all stages of the project lifecycle. BIM models for our Durapipe SuperFLO range of pipe, fittings and valves (metric only) are now available to download from the Durapipe website via [www.durapipe.co.uk/resources/bim](http://www.durapipe.co.uk/resources/bim)



## Healthy Water Systems

The choice of piping material has implications for water quality, in particular when it comes to fighting bacteria and biofilm in water systems.

A biofilm is an aggregate of microorganisms, and the ones that provide particular concern in building services pipework can cause legionella and pseudomonas. There is on average 300 reported cases of legionella per year in the UK.

We know that biofilm (microorganisms/bacteria) attaches itself to the rugged or jagged parts of the pipe. It thrives in dirt and will colonise where this is present, for example it likes sludge, scale and rust which form rugged or jagged surfaces.

Plastic pipework such as ABS has a smooth bore so there is nothing for biofilm to attach to which in turn limits its growth. So plastic has a clear advantage here over both new and a corroded/scaled metal pipe.

Biofilm will occur because bacteria is alive and lives in water. For the building owner/operator, it's all about monitoring and control of bacteria in their water systems, as no pipework material will completely combat the build-up of biofilm.

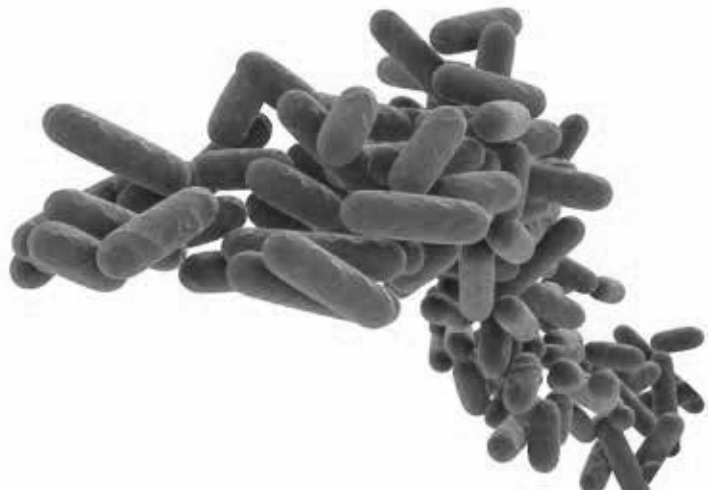

## Schools

### Edlington School, Doncaster

#### Application – Rainwater Harvesting

“SuperFLO offered superior performance levels for its particular application. The technical support and on-site training that was provided by Durapipe was excellent.”



**Ryan Street,  
NG Bailey**

### Stockbridge Village School, Liverpool

#### Application – Air Conditioning

“Durapipe SuperFLO eliminates the need for hot works and combined with its lightweight nature, significantly reduced labour time and cost for us.”



**Kevin Sykes,  
A&B Engineering**

## Healthcare

### Walsall Manor Hospital

#### Application – Boosted Cold Water

“With such a time-critical project, it was crucial that we selected products which would aid us in completing our installations on time.”



**Steve Baguley, Hilton  
Building Services**

### Care Home, Milton Keynes

#### Application – Boosted Cold Water

“We have been impressed with the pipework’s ease of installation and quality.”



**Tim Anders,  
Anders Plumbing**

## BUILDING SERVICES Case Study Examples

## Data Centres

### Atos Origin Data Centre

#### Application – Boosted Cold Water

“SuperFLO ABS doesn’t require any hot works, which helps save a lot of time and reduces safety worries on site. ABS is also limescale resistant and ductile at very low temperatures, which are important factors to consider for a system that will be carrying cold water constantly.”



**Andy Coles, CW Partnership**

### MOD Data Centre in Cyprus

#### Application – Boosted Cold Water

“We needed a system that could be easily and quickly installed. The low levels of preparation required with SuperFLO and its lightweight properties meant it was ideal for our needs.”



**Carl Davies,  
Southern and  
Redfern**

## Public Buildings/Accommodation

### British Museum

#### Application – Air Conditioning

“We used Durapipe ABS because of its long life span and cost-effectiveness in comparison to other pipework solutions.”



**Ashley Pursey, Romec**

### Glasgow Student Accommodation

#### Application – Cold Water

“SuperFLO is quick & easy to install and provides exceptional long-term performance capabilities.”



**Wayne Morgan,  
Vallectric**

## Industrial Manual & Actuated Valves

Durapipe offer a comprehensive range of manual valves as part of the SuperFLO ABS system to provide solutions for a wide range of industrial processes and applications.

Our valve offering includes the market-leading VKD ball valve, alongside metering, butterfly, diaphragm, ball check and air release valves.

Many of our valves include innovative patented design features with the latest technological developments to provide the end user with a high-quality valve tailored to a specific application, offering a variety of solutions for isolation, regulation, pressure relief, flow direction and system protection.

In addition to our extensive range of manual valves, we also offer a wide range of actuated valve solutions, that can be either electrically or pneumatically operated.

Our dedicated valve and actuation team can offer technical advice and assemble complex valve packages.

**Please contact our Valve Department on 01543 471681.**



## Flow Control

In addition to our manual and actuated valve range, we also offer an extensive range of technically advanced flow control equipment within our FLS range. The accuracy of flow control and measurement is crucial within industrial applications and is therefore important that adequate consideration is given to the type of flow control required. The Durapipe FLS range includes a range of Paddlewheel Flow Sensors, Variable Area Flowmeters, Flow Monitors, Magmeters and Batch Controllers, along with various installation fittings that can be used in conjunction with the Durapipe SuperFLO ABS system.



## Standards & Approvals

Durapipe SuperFLO ABS is manufactured to the highest level and exceeds the requirements of many international standards and approvals.

The system is WRAS approved and is also 'Approved for use within public water supplies and by the Secretary of State'. SuperFLO ABS is listed in the 'List of Approved Products' published by the DWI. Furthermore, our products are manufactured in an environment that complies with the requirements of ISO 9001 and ISO 14001.



Approved for use within public water supplies and by the Secretary of State. Durapipe ABS is listed in the "List of Approved Products" published by the DWI.

## Secondary Refrigeration

Recent years have seen an increase in the use of secondary refrigeration systems as a cost-effective and reliable alternative to traditional direct expansion refrigeration systems. This has been enhanced by government legislation banning the use of a number of Hydrocarbon HFC refrigerants by 2020 with GWP (Global Warming Potential) of above 2500, increasing the popularity of secondary loop refrigeration systems.

Secondary Refrigeration systems generally operate using low GWP refrigerants such as Glycol or Hycool with propylene glycol being the most popular, particularly in supermarket applications due to its non-toxic properties. Due to its corrosion resistant properties, Durapipe SuperFLO ABS is increasingly being utilised as a more effective and durable solution for secondary refrigeration systems. Its wide operational temperature range of -40°C to +60°C makes it ideal for a secondary refrigeration application, which typically operates at -15°C to -17°C.





## Water and Waste Treatment

### Thames Water, Hampshire

#### Application – Effluent Treatment

“Durapipe SuperFLO ABS was the most appropriate solution due to its lightweight material and maintenance free qualities.”

**Darren Brighton,**  
Tuke & Bell



### Wessex Water, Dorset

#### Application – Waste Treatment

“The team at Durapipe provided excellent service from the initial enquiry, continuing throughout the installation process.”

**Mike Back,**  
Damar Group



## Process Industries

### Wedge Group

#### Application – Contaminated Water

“Durapipe SuperFLO ABS was the obvious choice to carry our contaminated water, the product is reliable and hard-wearing.”

**Andrew MacLean,**  
Newport Galvanisers



### Water Purification Units

#### Application – Pure Water

“The pipework needs to ensure the water being carried does not become contaminated. We believe SuperFLO ABS is the best performing product on the market for our requirements.”

**Derek Spriggs,**  
EWS



## INDUSTRIAL Case Study Examples

## Marine and Offshore



### North Sea Oil Rig

#### Application – Potable Water via Reverse Osmosis

“It was imperative that the chosen pipework system could convey both seawater and potable water without compromising performance on either. I firmly believe SuperFLO ABS is the best product on the market to achieve this.”

**George Haworth,**  
Salt Separation Services

### Cruise Ship

#### Application – Chilled Water

“SuperFLO ABS pipework was ideal for the sophisticated requirements of this large chilled water installation.”

**Dirk Rötger,**  
Imtech Marine



## Food & Beverage



### Brecks Food

#### Application – Chilled Water Transportation

“We have been delighted with Durapipe UK from the initial enquiry, right through to the project completion, the technical support that we received from everyone at Durapipe throughout the project was exceptional.”

**Craig Dykes,**  
J Dykes Property Developments

### Brewery, Hampshire

#### Application – Glycol Transportation

“SuperFLO ABS’ simple joining technique meant that labour time & cost was significantly reduced which was a major influencer for us.”

**Adam Komrower,**  
Andwell Brewery





# Sustainability

## Introduction

Plastic piping systems are a sustainable and environmentally responsible choice that will serve generations to come. They are energy efficient during manufacturing and provide peak performance during service. Strong, durable, lightweight and flexible, plastic piping systems require significantly less energy to manufacture, transport and install than metal alternatives, and supply a long service life.

The cumulative energy requirements to manufacture, install and transport plastic pipework is estimated to be substantially less than most non-plastic systems.

Plastic saves energy – besides the technical advantages of plastics (eg. corrosion resistance) there are inherent benefits that contribute to energy efficiency and energy sustainability. The chain of activity outlined on the opposite page highlights where plastic has a positive impact compared to copper and steel which have a higher energy demand.



## Durapipe & Aliaxis

The continuous mission of Durapipe and the Aliaxis Group is to ensure our product offering is as sustainable as possible and considers the impacts on the environment whilst maintaining the highest quality and performance.

- Comply with all relevant environmental legislation, codes of practice and standards relating to quality and the environment.
- Continually improve the company's environmental performance, minimising any pollution risk and adopting best practice.
- Increase usage of recycled materials where appropriate.
- Take positive action to reduce waste by promoting energy conservation and recycling.
- Optimising production processes.
- Consolidating transportation routes across group companies.

## Durapipe Environmental Management System

Durapipe UK operates an environmental management system that has been successfully assessed against the BS EN ISO 14001 environmental management system.





## Ground Extraction of Raw Material

Plastics use only 4% of the world's oil as feedstock compared to 86% used for heating and transportation.

Most of this is recoverable via energy recovery, ie. plastics only 'borrow' energy during their lifetime and this can be recovered in the form of heat, which can be converted to electricity.

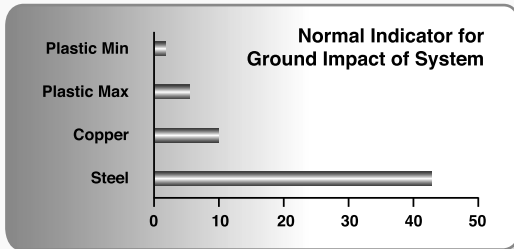

## Manufacturing

The energy used to make thermoplastic pipe & fittings from raw material compares favourably with, for example, steel pipe manufacture because lower conversion temperatures are needed.

Scrap during the manufacturing process of plastic can also be recycled and reused, which minimises the need for any thermoplastic pipe scrap entering the waste stream, presenting an example of eco-efficiency.

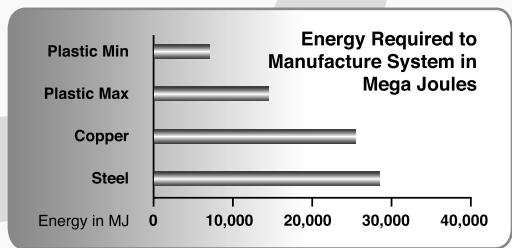

## Installation

On average a plastic pipework system is approximately 1/6th of the weight of an equivalent steel system. This means plastics are easier to install on-site with little or no requirement for expensive lifting equipment.



## Transportation

Thermoplastics pipe & fittings are cheaper and easier to transport because they are lighter in weight than equivalent metal pipes.

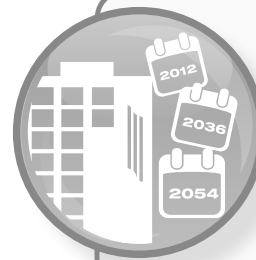

## System in Service

All plastic piping materials have low thermal conductivity resulting in less heat loss through the pipe wall. This characteristic could also minimise or eliminate the need for insulation.

Furthermore, due to very smooth inner pipe walls, thermoplastic piping materials have less turbulence, lower velocities and less friction loss than other piping materials.

This means less energy is required to move fluids throughout a system and a lower pump output.

## Carbon Impact - LCA

At **EVERY** stage of its lifecycle, plastic pipe systems reduce the level of energy consumption in comparison to metallic pipe systems.

**On a typical commercial building project, the real impact is:**

### Saving 2,314kg CO<sub>2</sub> Equivalent v Copper

This saving is the equivalent to:

- ✈ 8,550 miles by plane or
- 🚗 94,500 miles by car; equates to:
- ✈ 9.5 return flights from London to Paris
- 🚗 105 return journey by car from London to Paris

### Saving 3,606kg CO<sub>2</sub> Equivalent v Carbon Steel

This saving is the equivalent to:

- ✈ 13,239 miles by plane or
- 🚗 147,600 miles by car; equates to:
- ✈ 14.7 return flights from London to Paris
- 🚗 164 return journeys by car from London to Paris

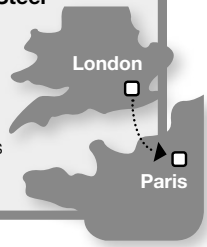

## Technical Information

### Maximum pressure/temperature relationship

When temperature of contents exceeds 20°C the working pressure of the system must be reduced accordingly (see table below).

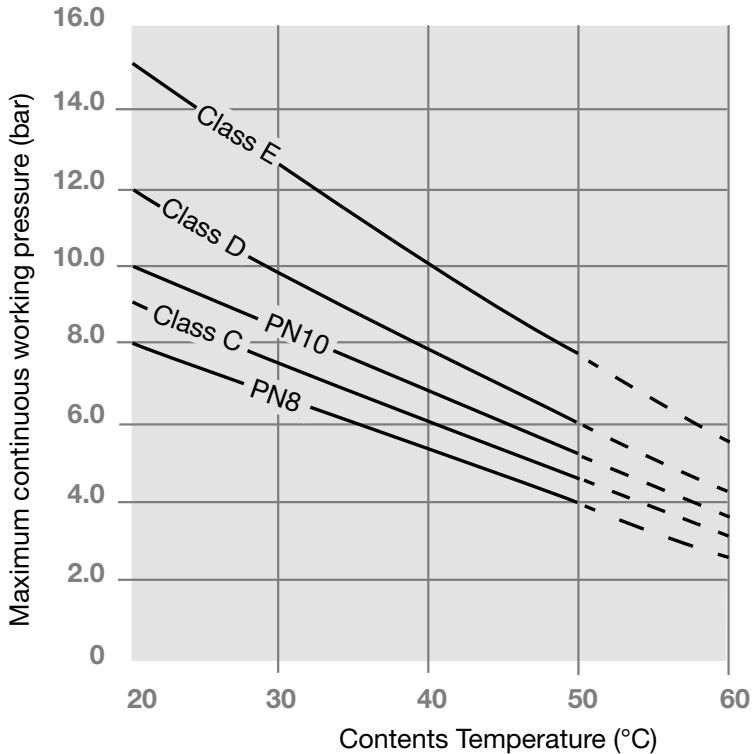

**Note:** For applications above 50°C please contact our technical support team.  
For applications/systems using VXE ball valves, please refer to the Durapipe Valves Technical Brochure.

### Fittings

The calculation of pressure drop in fittings is more complex but calculations can be made for equivalent lengths of straight pipe using the formula  $E = F \times D$  where:

- E = equivalent pipe length (metres)
- F = fittings constant (see table below)
- D = fitting internal diameter (mm)

To calculate the total pressure drop in the system, the equivalent straight pipe lengths for fittings is then added to the total straight pipe length to obtain the total drop.

#### Fittings constant

90° elbow	0.03
45° elbow	0.01
90° tee - straight through	0.01
90° tee - side branch	0.06
90° bend	0.01
45° bend	0.01
Reducing bush (per size reduction)	0.015
Butterfly valves	0.13
Diaphragm valves	0.23
Check valves	0.05

The values are included as a guide to aid calculation of overall system performance and should not be used in isolation.

### Flow calculations

Pressure drop due to friction in pipes conveying water can be determined using the Flow Nomogram on page 13.

The pressure drop at a given flow rate can be determined as follows:

1. Obtain the internal diameter of the pipe to be used by referring to the dimension table on the right:
2. Mark this diameter on Scale A.
3. Mark the required flow rate in litres per second on Scale B.
4. Draw a straight line connecting the points on Scales A and B and extend this to Scales C and D.
5. The velocity of flow in metres per second is determined from the intersection with Scale C.
6. The frictional head loss in metres per 100 metres of pipe can then be read off Scale D.

#### Table of Pipe Internal Diameters

Classes C to E in accordance with BS 5391 Part 1

Size	OD	Class C	Class D	Class E	Class T
3/8"	17.1			13.7	10.1
1/2"	21.4			17.4	14.2
3/4"	26.7			21.7	19.5
1"	33.6	29.6		27.4	25.0
1 1/4"	42.2	37.2		34.4	31.6
1 1/2"	48.3	42.7		39.3	36.3
2"	60.3	53.1		49.1	45.9
2 1/2"	75.2	65.0			
3"	88.9	78.5		72.3	
4"	114.3	101.1		93.1	
5"	140.2	121.8			
6"	168.3	148.5	142.7		
8"	219.1	193.7			

**Note:** Dimensions are given for guidance only, please contact our Technical Support Department for accurate information.

In accordance with ISO 161

Size	PN10
16	13.0
20	16.8
25	21.2
32	27.8
40	34.6
50	43.2
63	54.6
75	65.0
90	78.0
110	95.4
125	108.6
140	121.6
160	139.0
200	173.6
225	195.4
250	217.8
315*	273.4

\*315mm is PN8 rated.

**Flow Nomogram**

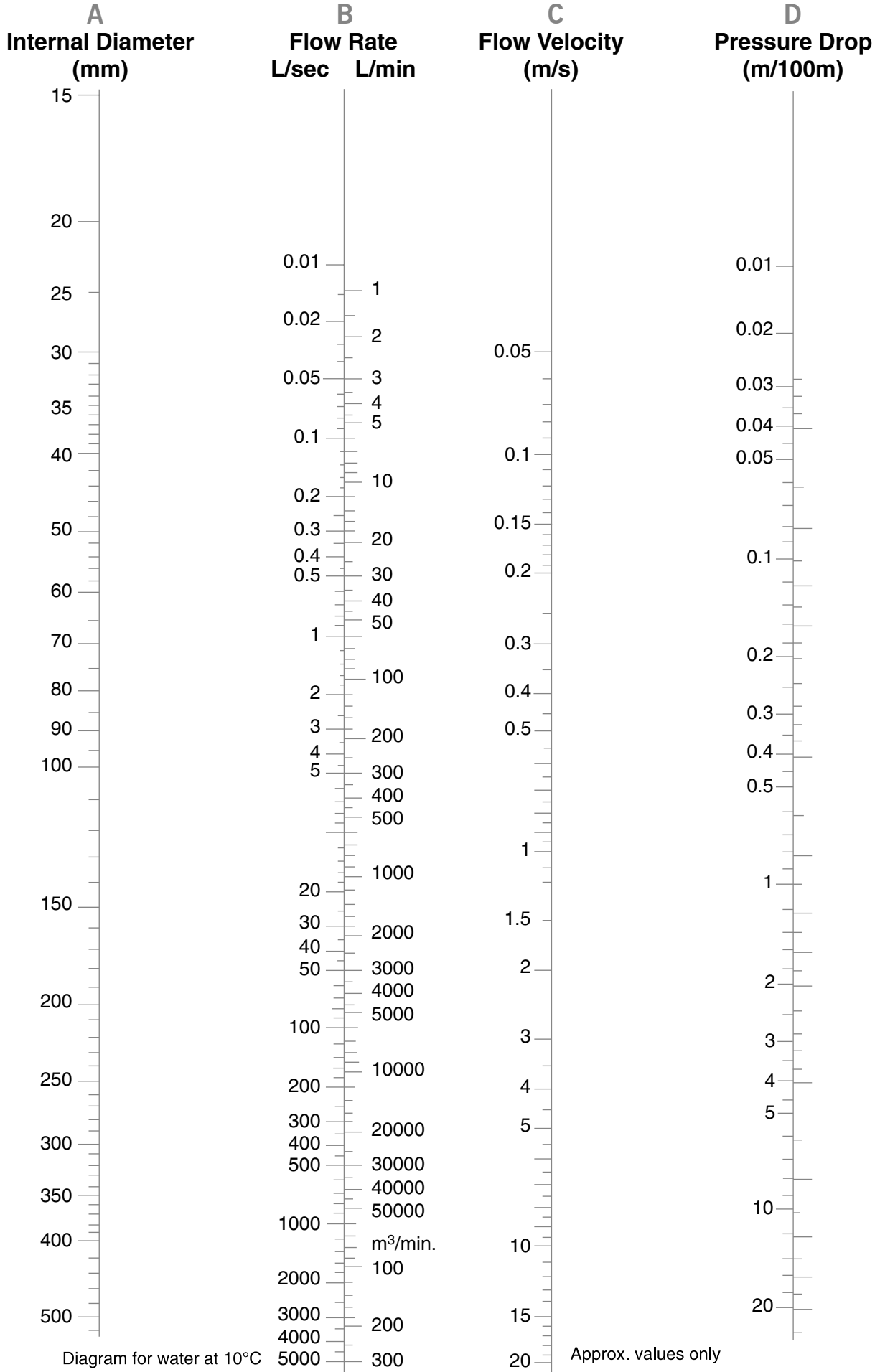

## SuperFLO ABS Jointing Guide

Solvent cement welding offers a simple and quick means of constructing high integrity, leak-free joints.

The solvent cement operates by chemically softening the joint surfaces. Joint integrity will be greatly reduced if these surfaces are not clean and properly prepared.

Durapipe SuperFLO ABS solvent cement **must** be used. The jointing procedure detailed below must be followed.

When using 'One-step' solvent cement, it is not necessary to abrade pipe or fitting (unless making a joint on to old ABS pipe).

No attempt should be made to increase the clearance between the pipes and fittings.

### Procedure

1. The pipe must be cut clean and square. A suitable wheel cutter will eliminate swarf. As an alternative (and on larger sizes) a carpenter's saw should be used, however this may create dust and swarf which can enter the system.



2. Chamfer the end of the pipe using a coarse file or suitable chamfering tool. The chamfer should be approximately 45° by 3mm to 5mm depending on the pipe size. Reducing bushes should also be chamfered (unless where a moulded chamfer is included).



3. Mark the pipe a known distance from the end and clear of the area to be cleaned. This mark should be used to confirm full insertion of pipe into socket of fitting.

Watch our jointing videos online at [www.durapipe.co.uk/technical-support/jointing-videos/](http://www.durapipe.co.uk/technical-support/jointing-videos/)



4. Ensure joint surfaces are clean and free from moisture. Clean surfaces thoroughly with Durapipe Eco-cleaner using lint free cloth/paper towel.



5. Using a clean brush apply cement to the pipe and fitting. The joint surfaces should be completely covered by cement. Cement should be applied using an appropriate size brush and tin of cement. It is important to apply cement quickly to enable assembly without excessive force being required. When applying cement with brush, the size of the brush should be approximately half the size of the pipe to be jointed - brush size up to 2 1/2" (63mm) for 0.5 litre and up to 3" (75mm) for 1 litre tins.

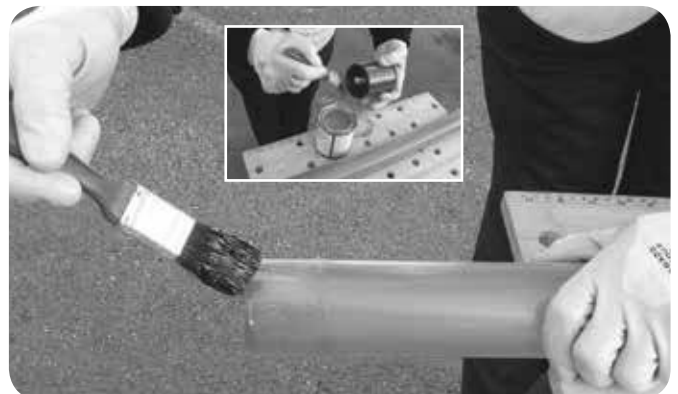

6. Immediately after applications of cement, push pipe fully home into the fitting. Do not twist. Hold the pipe and the fitting for times varying from a few seconds on sizes 3/8" or 16mm up to 1 minute on size 315mm. The slight taper moulded into the fitting may otherwise cause it to slide off the pipe with consequent loss of joint strength. Application of the correct amount of cement will result in a neat bead of cement at the edge of the fitting and at the edge of the pipe. Excessive deposits inside the fittings must be avoided as these can weaken the wall, particularly on smaller sizes. When working under cold conditions make sure the joints are free from frost and moisture.



7. Wipe off excess cement from the outside of the joint.



8. Using the mark previously made, check that the pipe has been fully inserted.

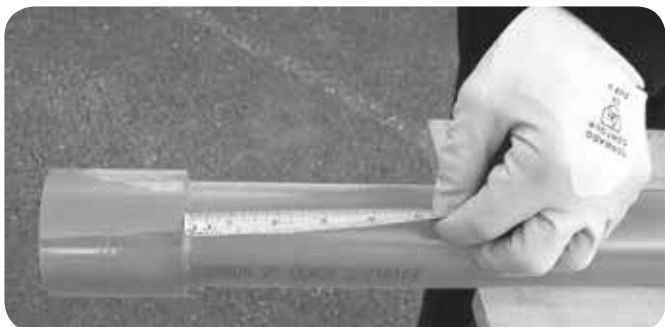

9. Do not disturb a joint for least 10 minutes. On larger sizes do not subject the joint to bending or twisting forces for at least 4 hours. When making subsequent joints, which can be done without waiting, take care not to transmit forces to freshly made joints in the system.
10. Replace lids on containers.

### CAUTION

- DO NOT use near naked flames
- DO NOT smoke in the working area
- DO NOT use in confined spaces
- DO NOT joint in the rain or wet conditions
- DO NOT use dirty brushes
- DO NOT use dirty or oily cleaning cloths
- DO NOT use the same brushes for different cements
- DO NOT dilute or decant SuperFLO ABS solvent cement
- Follow safety instructions on Durapipe solvent cement and Eco-cleaner containers
- Always wear appropriate personal protective equipment

### Notes

1. The integrity of SuperFLO ABS systems may be affected if SuperFLO ABS One-step solvent cement and Durapipe Eco-cleaner are not used. Durapipe UK disclaims responsibility for any SuperFLO ABS system constructed with any other cement or not fabricated in accordance with the instructions herein.
2. Use the appropriate size of solvent cement tin/container and method of application for the size of pipe and fitting to be assembled.
3. To achieve the correct speed of application on sizes 5"/140mm and above, cement should be applied simultaneously to pipe and fitting, by two people.

### Drying times

The drying times will vary with fit, amount of solvent cement applied, ambient temperature and working pressure. It is recommended that, wherever possible, joints of sizes up to 8"/225mm are allowed to dry for at least 24 hours, and sizes 250mm and 315mm for at least 48 hours.

These guidelines are based on an ambient temperature of between 10°C to 40°C. Longer drying times will be required at lower and higher ambient temperatures.

It is recognised that there will be occasions when the system will need to be put into service within a few hours of being made. A rough but safe working guide where the ambient temperature is between 10°C to 40°C and the contents temperature does not exceed 20°C is as follows:

Size Range	Up to 2 1/2" 75mm	3" to 4" 90mm to 125mm	5" & 6" 140mm & 160mm	8" 200mm & 225mm	250mm & 315mm
Drying Time	0.5 hour / bar	1.0 hour / bar	1.5 hours / bar	2.0 hours / bar	48 hours minimum

Note - minimum drying period should never be less than 1 hour.

Drying times should be extended where ambient temperatures are below 20°C. Solvent cement joints should not be made below 0°C. For more details contact the Durapipe Technical department.

An indication of the number of joints to be made per litre of cement is as follows:

Size mm	inch	Recommended container size	Joints per litre ABS
16 - 32	3/8 - 1	0.5 Litre	400
40 - 63	1 1/4 - 2	0.5 Litre	200
75 - 110	2 1/2 - 4	0.5 Litre	70
125 - 140	5	1 Litre	20
160 - 225	6 - 8	1 Litre	10
250 - 315	-	1 Litre	5

## Branch connections - reduced bore

Reduced branch connections can be made as follows:

### Imperial range:

Bushed equal tees or Y-Pieces, solvent cemented saddles.

### Metric range:

Bushed equal tees or Y-Pieces, reduced branch tees.

Saddles permit branch connections to be made with the main pipe in situ. The following procedure must be followed carefully:

1. After making sure that the pipe is empty, drill a hole in the pipe wall to suit the connection. The size of hole and cutter size to be used for each size of saddle is indicated below:

Pipe size (Imperial)	Hole diameter (mm)	Cutter size (Imperial)
2	48	17/8
3	61	23/8
4	74	27/8
6	74	27/8



2. Mark out the area covered by the saddle on the pipe.



3. Clean surfaces with Eco-cleaner.



4. Feed on to pipe two worm drive (Jubilee) clips which will clamp the saddle during fitting. These should be placed either side of the socket on the saddles. Apply cement to pipe area and saddle. **It is important to apply cement quickly.**



5. Position saddle immediately, ensuring that spigot locates in hole in pipe wall. Clamp in place using worm drive clips without delay.



6. Wipe off any excess cement.



7. Replace lids on containers.
8. Clean brush with Eco-cleaner.



### Important:

1. See page 15 for details of drying times. Allow 24 hours before removing straps.
2. On no account should a branch tee be constructed by drilling through the wall of a pipe and/or fitting and attempting to solvent weld a smaller fitting into the hole.



## The use of bushes, reducers and threaded adaptors

### Reducing bushes

Reducing bushes offer a neat and simple method of reducing socket size in the minimum of space.

Care must be taken to properly prepare all jointing surfaces as recommended earlier, with the end of the bush being chamfered (unless a moulded chamfer is included).

### Example in the use of reducing bushes

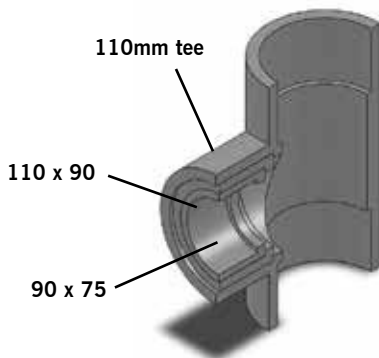

### The use of reducers

All fittings have female ends, dimensionally controlled for cold fusion jointing. In addition, reducing sockets in the Metric series have controlled outside diameter at the larger end. This allows use as a male or female component, as illustrated.

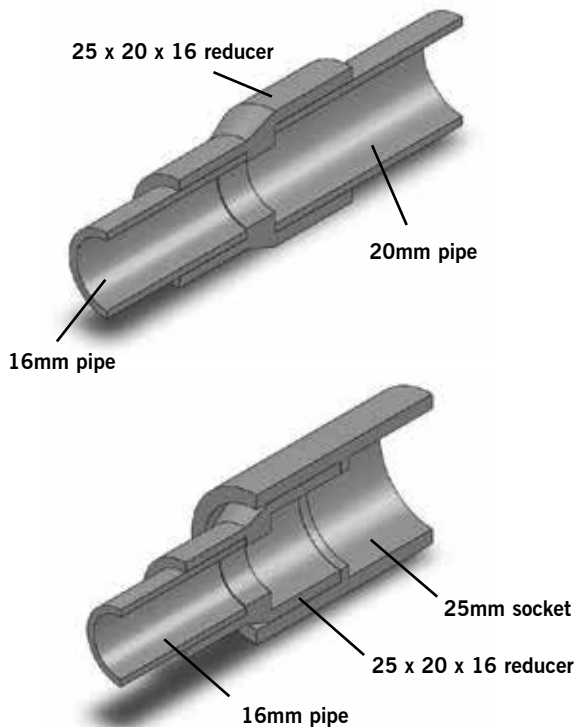

### Metric series threaded adaptors

Female and male threaded adaptors have controlled inside and outside diameters on the plain end. They can therefore be used as a male or female component.

## SuperFLO ABS flexible hoses

SuperFLO flexible hoses have been introduced in response to customer demand and are specially designed to allow direct connection from Durapipe SuperFLO pipework to operating equipment.

If pipework is either short of a connection or at a higher or lower level to ancillary equipment, the braided flexible hoses can be solvent welded to SuperFLO pipework and then connected to operating equipment using a female threaded connection, forming a durable, leak-free fusion.

Manufactured in 300mm and 600mm lengths as standard, with additional sizes available on request, SuperFLO flexible hoses come in a choice of 20mm, 25mm and 32mm diameters. With an internal hose made from EPDM rubber, SuperFLO flexible hoses are also compliant with BSRIA Flexible Hose Standard BG4/2004.



## Threaded connections

### Connections - plastics to metal

There are several recommended methods to connect metal and plastic systems:

Composite unions

Flanges

Male threaded fittings

Female threaded fittings

Plastics expand or contract more than metals for any given change in temperature. The practice of connecting plastic threaded fittings to metal threads is not recommended where the joint is likely to experience a temperature change of more than +/-5°C, otherwise leaks may occur.

Composite unions are available with brass male or female BSP threaded adaptors.

If it is required to cut a thread onto SuperFLO ABS pipe, use a sharp die especially reserved for plastic pipes and cut full thread depth without lubricant, in one operation.

This should only be attempted on pipe sizes up to 2" NB. Class T pipe must be used. Pipes from SuperFLO ABS metric range are not suitable for threading.

Assembly should be carried out by hand and final tightening by a strap wrench, if necessary.

Extra care must be taken not to overtighten or damage the thread.

### Pipe wrenches must not be used

It is recommended that PTFE tape or Fibre Seal be used when making plastic threaded joints/connections. Any other sealing compound must be confirmed by Durapipe UK as being suitable, as certain sealants (e.g. Boss Universal and Loctite 577) can chemically attack ABS and must not be used.



### Connection to instrumentation

Instrumentation connections can be made by drilling through pipe and socket where the material is at its thickest and tapping the hole to receive a threaded fitting, as shown below:

Pipe size	Connection size
16mm-63mm/3/8"-2"	Use tees, reducing bushes and threaded fittings
75mm-110mm/2 1/2"-4"	Max. tapping 1/2" BSP
125mm-140mm/5"	Max. tapping 3/4" BSP
160mm & above/6" & above	Max. tapping 1" BSP

Such connections, if correctly drilled and tapped with full thread form, will be limited to Class C/PN10 pressures.

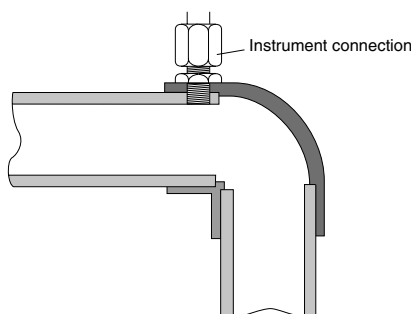

## Flanged joints

Full face flanges are available from 1/2" to 6".

Stub flanges are available from 2" to 8" and in metric sizes from 16mm to 315mm and provide a convenient means of converting from Imperial to Metric systems in sizes 8"/200mm and above.

The correct galvanised mild steel backing ring and rubber gasket must be used with both types.

### Flange bolting procedure

The following procedure is recommended for installing SuperFLO ABS flanges:

1. Inspect flange faces and ensure that they are clean and undamaged.
2. Check that the correct backing ring and rubber gaskets have been supplied. Durapipe supplies a matched system of flanges and backing rings - do not interchange Metric and Imperial components.
3. Loosely assemble flanges. Ensure that flanges and bolt holes align and that the flange faces are parallel. Ensure that the gasket is correctly positioned between the flanges.
4. Ensure that the appropriate sized washer is placed under both bolt heads and nuts.
5. Tighten the nuts and bolts in a diagonally opposite sequence (see below) to ensure even loading around the flange to avoid distortion. It is recommended that the nuts and bolts be tightened as uniformly as possible progressively from a finger tight start.
6. Repeat as necessary until tightness of all bolts is achieved.

## Tightening torques for flange bolts in SuperFLO ABS piping systems

### Recommended Torque Values (Nm)

Size	Torque
16mm - 3/8"	15
20mm - 1/2"	15
25mm - 3/4"	15
32mm - 1"	15
40mm - 1 1/4"	20
50mm - 1 1/2"	30
63mm - 2"	35
75mm - 2 1/2"	40
90mm - 3"	40
110mm - 4"	40
125mm	50
140mm - 5"	50
160mm - 6"	60
200mm	70
225mm - 8"	70
250mm - 10"	80
315mm - 12"	100

The tolerance on torque is +/-10%

### Tightening sequence

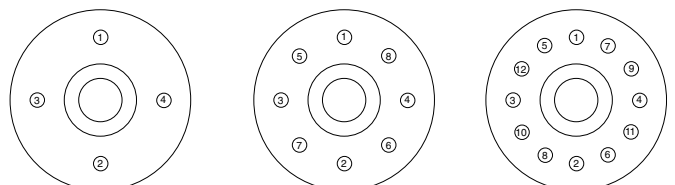

## Pipe routing

Systems installed above ground should be designed such that there are sufficient changes in direction to accommodate expansion or contraction. The support method described below will ensure that the pipework can move axially, without snaking. Utilise all available pipe flexibility. Do not place clips too close to changes in direction.

## Calculating expansion and contraction

Temperature variations in a pipework system will increase or decrease the length of each pipe. This is the result of temperature changes in the fluid carried and also from ambient temperature variations. The rate of expansion or contraction of pipework is dependent on its length, its coefficient of expansion and the temperature difference.

Increase/decrease in pipe length is given by the formula:

$$\text{Expansion} = L \times \alpha \times \Delta T$$

where:  $L$  = length (mm)  
 $\alpha$  = coefficient of linear expansion  
 $\Delta T$  = temperature difference of the pipe (°C)

The coefficient of linear expansion for SuperFLO ABS:  
 $10 \times 10^{-5}$  per °C

Rule of thumb: ABS expands/contracts 1mm/metre/10°C temperature change:

### Example:

What is the expansion/contraction of an insulated, 30m long, ABS Condenser water main, installed at 15°C, operating at a maximum temperature of 35°C and a minimum temperature of 5°C?

#### Expansion:

$$\begin{aligned} L &= 30,000 \text{ mm} \\ \alpha &= 10 \times 10^{-5} \\ \Delta T &= 35 - 15 = 20^\circ\text{C} \\ \text{Expansion} &= 30,000 \times 10 \times 10^{-5} \times 20^\circ\text{C} \\ &= \underline{60\text{mm}} \end{aligned}$$

#### Contraction:

$$\begin{aligned} L &= 30,000 \text{ mm} \\ \alpha &= 10 \times 10^{-5} \\ \Delta T &= 15 - 5 = 10^\circ\text{C} \\ \text{Contraction} &= 30,000\text{mm} \times 10 \times 10^{-5} \times 10^\circ\text{C} \\ &= \underline{30\text{mm}} \end{aligned}$$

Hence the system must be designed, using expansion loops, the natural flexibility of pipe, or expansion bellows, to cater for a differential movement, with an expansion of 60mm and a contraction of 30mm.

The system should be designed to cater for the greater amount of movement of either expansion or contraction.

## Catering for pipe movement

Systems installed above ground should be designed to ensure that there are sufficient changes in direction to accommodate expansion and contraction. The support method described later will ensure that the pipework can move axially without snaking. If sufficient changes in direction are not available within the design of the system, alternative methods of catering for pipe movement can be considered such as expansion loops or flexible rubber bellows.

## Expansion loops

The length of unrestrained pipe (free leg length) required to accommodate expansion can be calculated from the graph overleaf.

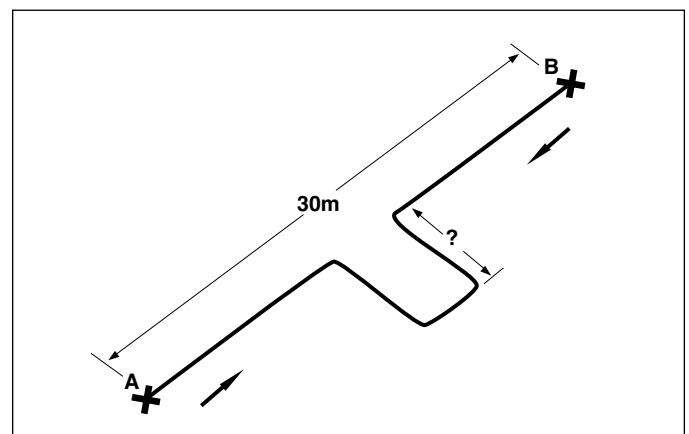
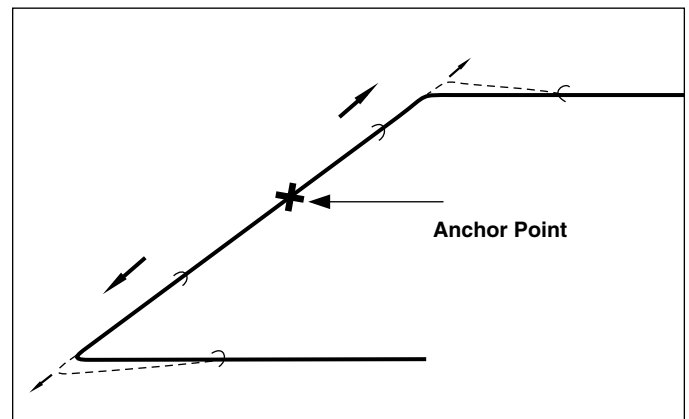
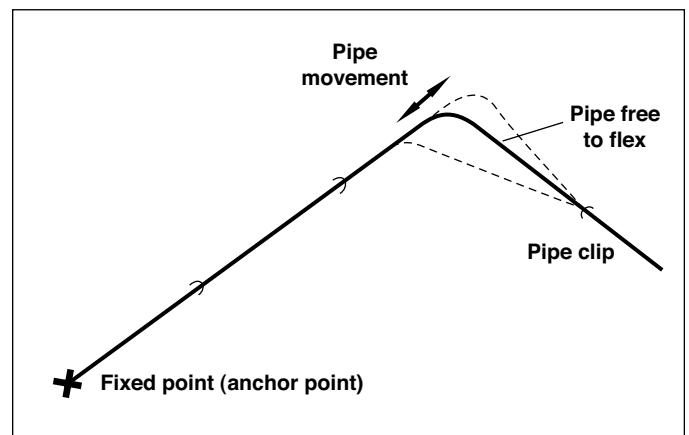

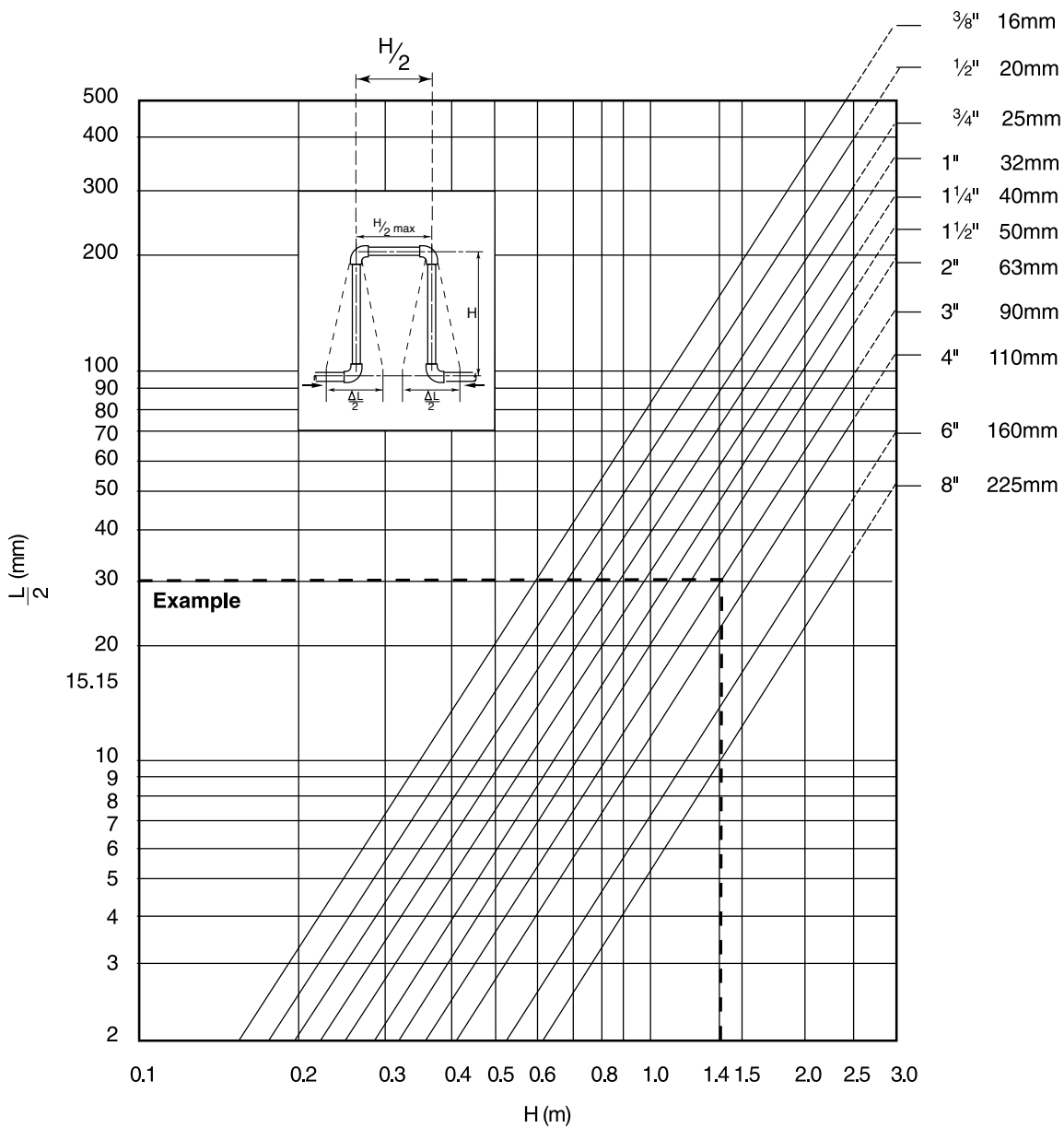

**Example:**

What is the anticipated change in length of a 20 metre run of SuperFLO conveying chilled water? The system is in the UK and is expected to be ready for commissioning during July or August. The CHW flow will run at 6°C and will return at 12°C. It will be insulated after pressure testing and commissioning is completed.

**Calculation:**

Ambient temperature indoors will probably be in the range of 20°C to 30°C. Assume pipe temperature prior to commissioning as (worse case) = 30°C.

Maximum change in pipe temperature will occur in CHW flow pipe, ie. 30 - 6 = 24°C.

The change in length, therefore, (using '1mm/metre/10°C') is 2.4mm/metre. The change in length of a 20 metre run will be 2.4 x 20 = 48mm.

**Answer:**

As the pipe cools from 30°C to 6°C it will contract by 48mm.

### Expansion bellows

Bellows may also be used in place of or in conjunction with the natural flexibility of the SuperFLO ABS. These must be approved for use by the bellow manufacturers for use with thermoplastic pipework. Bellows must be installed in accordance with manufacturer's recommendations.

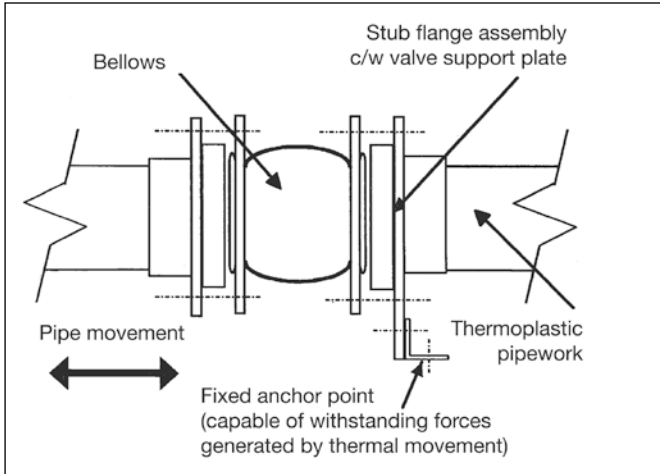

### Anchor points

The direction of pipe movement can be controlled by the use of anchor points at strategic positions. There are a number of methods of securely anchoring plastic pipes, some of which are detailed below. However it should be noted that tight fitting pipe supports should not be used since damage to the pipe could occur.

**Note:** See above for advice on anchoring of bellows.

### Construction of typical anchor points

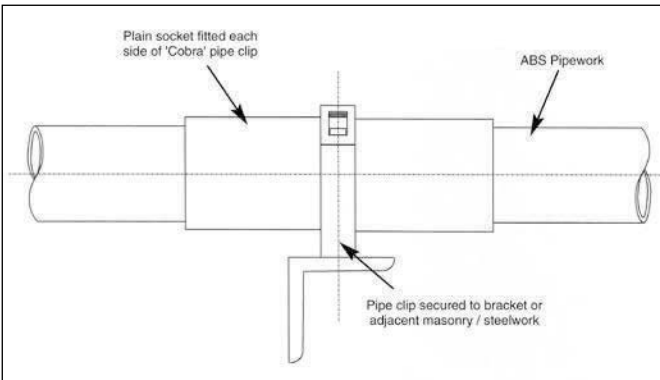

1. Small Bore (up to 4" Pipework)

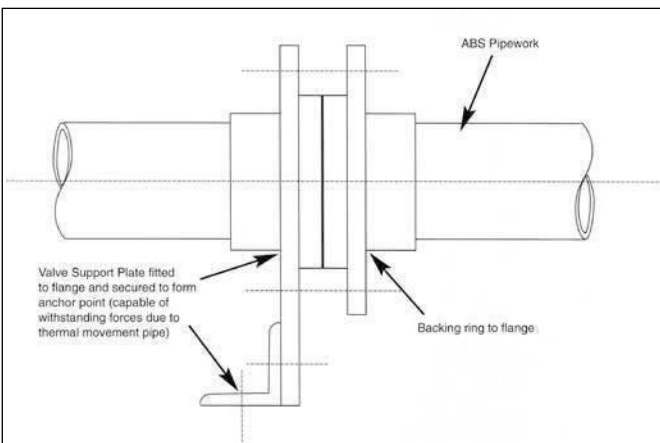

2. Larger pipe (above 4" Pipework)

### Pipe supports and clips

Pipe supports and clips should provide lateral restraint and allow free, unrestricted, axial pipe movement. Standard 'drop rods' may not provide sufficient lateral restraint and the SuperFLO ABS pipe could start to 'snake'.

Durapipe Cobra clips are designed to meet these requirements.

A suitable alternative would be mild steel saddle clips designed with a clearance between the pipe and the clip. All steel brackets in contact with the plastic pipe should be free of sharp edges to avoid damaging the pipe.

### Support centres

The recommended distance between supports for SuperFLO ABS pipes filled with water is given in the table below. This table is based on the thinnest wall pipe in each size. For sizes 1", 1 1/4", 1 1/2", 2", 3" and 4" the support distance can be increased by 10% for class E pipes. Where the contents have a specific gravity greater than 1, the distance must be decreased by dividing the recommended centre distances by the specific gravity. The details shown are for horizontal pipes. For vertical pipes, support centres may be increased by 50%.

Size mm/imperial	Support distance (m) at 20°C	Support distance (m) at 50°C	Support distance (m) at 60°C
16mm / 3/8"	0.8	0.5	0.4
20mm / 1/2"	0.9	0.6	0.5
25mm / 3/4"	1.0	0.7	0.6
32mm / 1"	1.1	0.8	0.7
40mm / 1 1/4"	1.2	0.9	0.7
50mm / 1 1/2"	1.3	1.0	0.7
63mm / 2"	1.4	1.1	0.8
75mm / 2 1/2"	1.5	1.2	0.8
90mm / 3"	1.6	1.2	0.9
110mm / 4"	1.8	1.3	1.0
125mm	1.9	1.4	1.0
140mm / 5"	2.0	1.5	1.1
160mm / 6"	2.1	1.6	1.2
200mm	2.2	1.7	1.3
225mm / 8"	2.3	1.8	1.5
250mm	2.5	2.0	1.7
315mm	2.9	2.4	2.1

### Support of heavy equipment

Large valves, strainers and other heavy equipment should always be independently supported to prevent undue loading onto the SuperFLO ABS system. Durapipe valve support plates have been designed for this purpose and may be used in place of flange backing rings.

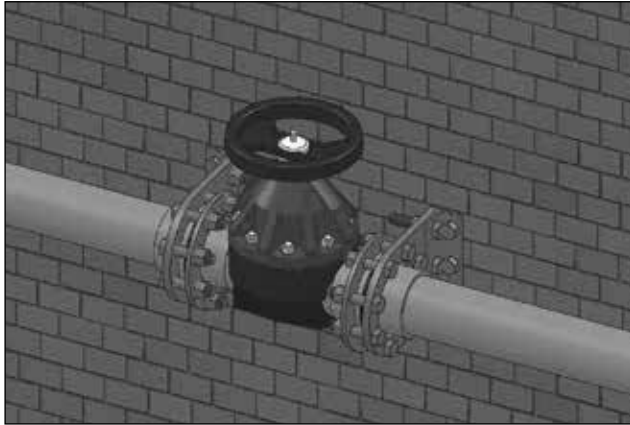

### Anchor blocks

For wholly solvent welded systems the pipework is pressure balanced and anchor thrust blocks are not required.

When rubber ring joints are used it is necessary to provide concrete anchor blocks at all sudden changes in direction such as elbows, bends, tees etc. This is necessary to withstand the forces generated by system pressurisation.

For greater detail, users in the UK are recommended to study the Code of Practice CP 312 published by the Pipe and Fittings Group of the British Standards Institute covering installations above and below ground.

### Buried pipes

Recommendations covering essential requirements for installations below ground may be summarised as follows:

In general, trenches should not be less than a metre deep. Trenches should be straight sided, approximately 300mm wider than the pipe diameter to allow proper consolidation of packing materials.

Trench bottoms should be as level as is practical.

Large pieces of rock, debris and sharp objects should be removed.

Alternatively gravel can be laid approximately 100mm deep on the floor of the trench. (Sand may be used but subterranean water is liable to wash sand away and leave the pipe unsupported.)

If pipes are jointed above ground, they should remain undisturbed for 2 hours before being lowered into the trench.

After laying, pipes should be covered with gravel or similar material to a depth of 100mm above the crown of the pipe. The gravel should be extended sideways to both trench walls and compacted. This should be done prior to testing, with joints left exposed.

Care should be taken to ensure that sharp objects, stones, etc, are prevented from falling into the trench before covering the pipe.

After pressure testing, joints should be covered with gravel or similar material, and back filling completed.

A section of pipe installed below ground to the above recommendations is shown in the illustration.

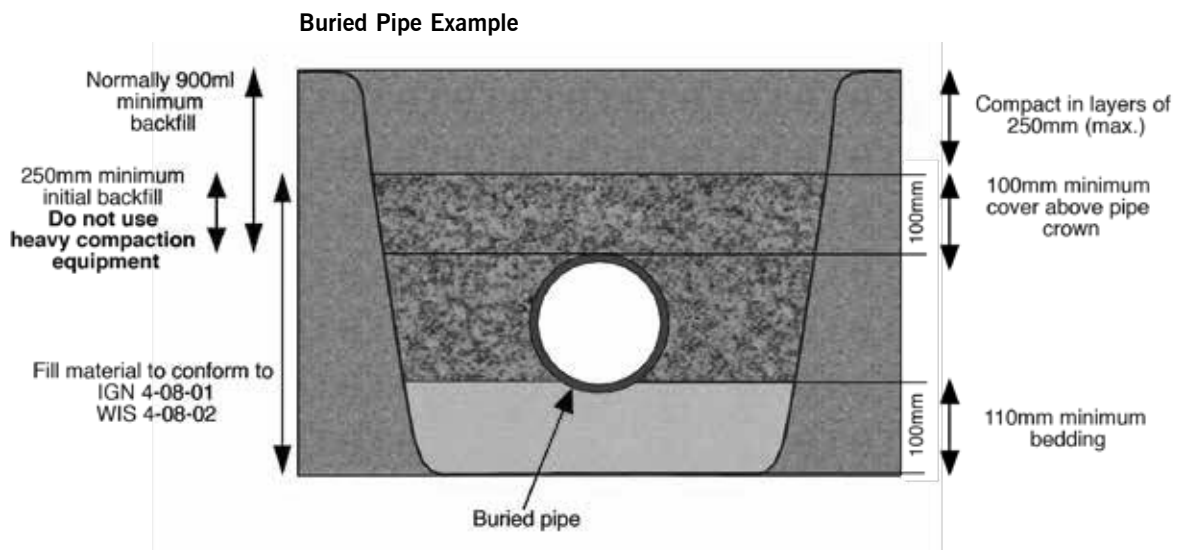

## Additional Important Information

### Thermal insulation

Some insulation products can contain substances capable of having a detrimental effect on thermoplastic pipework eg. certain types of foam rubber insulations can cause pipes to fail where the SuperFLO ABS is conveying liquids at temperatures above 30°C.

Recommended insulation - a list of some of the common types of insulation materials known to be suitable with SuperFLO ABS pipework are as follows:

Fibre wool, such as 'Rockwool'

Armaflex Class 1 HT

Koolphen K Phenolic foam

Polystyrene

Note - the above list is not exhaustive – please contact our Technical Support Department if further assistance is required.

Some adhesives can also be detrimental. Do not bond insulation to SuperFLO ABS. (This comment also applies to any tapes, adhesives, or other substances used to secure the heating tape to the pipework.)

### Trace heating tapes

The selection of heating tapes with silicone rubber, woven wire or woven polyester outer sheaths will eliminate the risk of plasticiser migration. These tapes are therefore preferred for use on thermoplastic systems.

### Flexible hoses

Durapipe SuperFLO ABS flexible hoses are completely compatible with the full system. However other flexible hoses are known to contain plasticisers such as phthalates which can be harmful to ABS. Please contact our Technical Support Department if further advice is required.

### Pipe contents identification

Do not put self-adhesive labels directly on to pipe surfaces as this may be detrimental to pipe performance. It is recommended that some sort of barrier, such as aluminium foil, is placed between pipe and identification label.

### Intumescent mastic and mastic sealants

Certain mastic sealants are formulated with phthalates. Phthalates are known to be extremely aggressive toward SuperFLO ABS materials, and therefore confirmation of the suitability of any mastic sealant should be determined before being used in conjunction with SuperFLO ABS pipework.

### Pipe clips

It is important that the composition of pipe clips and their linings do not include substances which might have a detrimental effect upon the SuperFLO ABS pipe. Please check for suitability before use. We strongly recommend the use of Durapipe Cobra clips or Durapipe rubber lined clips for pipe sizes up to and including 160mm OD / 6"NB, wherever circumstances allow.

### Pneumatic testing

Pneumatic testing is not recommended because of the risk to personnel or property if, for example, a joint has been temporarily assembled without solvent cement and has then been mistakenly left in that condition. Such joints could separate suddenly and violently during the test.

Also, leak detection sprays designed to detect air leaks on steel pipework can damage thermoplastics.

### Contact with synthetic oils

Some synthetic oils are unsuitable for use with thermoplastic pipe systems. The main types of synthetic oils identified as being incompatible with thermoplastic pipe systems includes Esters, Polyalkylene Glycols and Organic Phosphates.

It should be noted that some metal coil manufacturers use these oils in their manufacturing process. This is normally drained from the coil. If it is suspected that residues of oil may remain in the coil it should be filled with methylated spirits, then thoroughly flushed with water.

### Freezing conditions

Precautions should be taken to prevent contents freezing, as this can cause pipework to split.

Mono-ethylene glycol can be added to the system to lower the freezing point. See opposite for advice on insulation and trace heating.

### Contact with fluxes

Some fluxes can be detrimental to SuperFLO ABS. Care should be taken when soldering copper pipework directly above, or close to, SuperFLO ABS pipework.

### Buried pipes

Do not lay SuperFLO ABS in contaminated ground eg. 'brown-field' sites. Do not lay SuperFLO ABS in ground where spillages of chemicals may occur.

### Thread sealants

Some thread sealants can damage SuperFLO ABS. PTFE tape or Fibre Seal should be used when making threaded connections. See page 18 for further information.

### Resistance to UV (sunlight)

Care should be taken to avoid exposure to UV light, eg. sunlight, particularly during storage. This will cause discoloration and deterioration of the SuperFLO ABS material. It is recommended that precautions be taken to prevent this happening. If stored outdoors pipe should be covered with opaque sheeting. If installed outdoors it can be protected from the effects of UV by insulating or painting.

### Pressure surges

Durapipe SuperFLO ABS pipework can withstand pressure surges within the limitations detailed within CP312 Part 2:1973 and its amendment dated 1977.

On no account should pressure surges be allowed to exceed the maximum continuous working pressure calculated using the graph on page 12.

## Comparison of SuperFLO ABS Imperial and Metric Sized Pipe

Tabulated below is a comparison of imperial and metric sized SuperFLO ABS pipe. They are produced to different standards, but can be joined together using flanges or adaptors.

The systems are also designated differently; the imperial system refers to the nominal bore size; the metric system relates to the outside diameter.

Both systems are produced with the outside diameter as the controlled dimension. This enables the same fitting of a particular size to be joined to all classes of pipe in that size.

Please refer to the pipe section in this brochure for pipe sizes available from Durapipe UK.

### Threaded systems

Imperial system Class T ABS pipe can be machined to BSP parallel or BSP taper thread forms. Metric pipe is not produced with an outside diameter suitable for threading.

Imperial System (BS 5391)							Metric System (ISO 15493)	
Size (nominal bore) (imperial)	Minimum mean outside diameter (mm)	Minimum wall thickness (mm)					Size outside diameter (mm)	Minimum wall thickness (mm) PN10
		Class B	Class C	Class D	Class E	Class T		
3/8	17.1	-	-	-	1.7	3.5	16	1.5
1/2	21.4	-	-	-	2.0	3.6	20	1.5
3/4	26.7	-	-	-	2.5	3.6	25	1.5
1	33.6	-	2.0	-	3.1	4.3	32	1.9
1 1/4	42.2	-	2.5	-	3.9	5.3	40	2.4
1 1/2	48.3	-	2.8	-	4.5	6.0	50	3.0
2	60.3	-	3.6	-	5.6	7.2	63	3.8
2 1/2	75.2	-	5.0	-	-	-	75	4.5
3	88.9	-	5.2	-	8.3	-	90	5.4
4	114.3	-	6.6	-	10.6	-	110	6.6
-	-	-	-	-	-	-	125	7.4
5	140.2	-	9.3	-	-	-	140	8.3
6	168.3	-	9.9	12.8	-	-	160	9.5
-	-	-	-	-	-	-	200	11.9
8	219.1	-	12.7	-	-	-	225	13.4
-	-	-	-	-	-	-	250	14.8
-	-	-	-	-	-	-	315	18.7*

2 1/2" and 5" pipes are PN10 rated.

\*315mm is rated at PN8.

### Properties guide

Chemical resistance and performance data	Typical applications	Unsuitable for the following uses	Sizes and jointing information
Moderately strong mineral acids Caustic and ammoniacal solutions Most inorganic salt solutions Some detergents Temperature range -40°C to +60°C	Chilled water Low temperature brine Potable water Process water	Applications over 60°C Bleaches Solvents Domestic hot water Flammable substances	Metric: 16mm to 315mm OD Imperial: 3/8" to 8" NB Jointed by solvent cement welding Threaded fittings available

**Note:** Temperatures given are for guidance only, please check before specifying.  
For applications above 50°C please contact our technical support team.



## General Information

### Handling and storage

The high impact strength of SuperFLO ABS systems provides some protection against damage but care should be taken at all stages of handling, transportation and storage.

Pipe must be transported by a suitable vehicle and properly loaded and unloaded, eg. wherever possible moved by hand or mechanical lifting equipment. It must not be dragged across the ground.

The storage should be flat, level and free from sharp stones.

### Lengths

Pipe lengths stored individually should be stacked in a pyramid not more than one metre high, with the bottom layer fully restrained by wedges. Where possible, the bottom layer of pipes should be laid on timber battens at one-metre centres. On-site, pipes may be laid out individually in strings. (Where appropriate, protective barriers should be placed with adequate warning signs and lamps.)

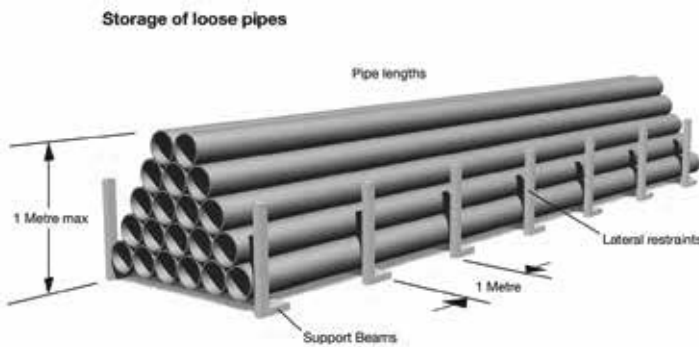

### Bundles

Bundled packs of pipe should be stored on clear, level ground with the battens supported from the outside by timbers or concrete blocks. For safety, bundled packs should not be stacked more than three metres high.

Smaller pipes may be nested inside larger pipes. Side bracing should be provided to prevent stack collapse.

Similar precautions should be taken with fittings and these should be kept in protective wrappings until required for use.

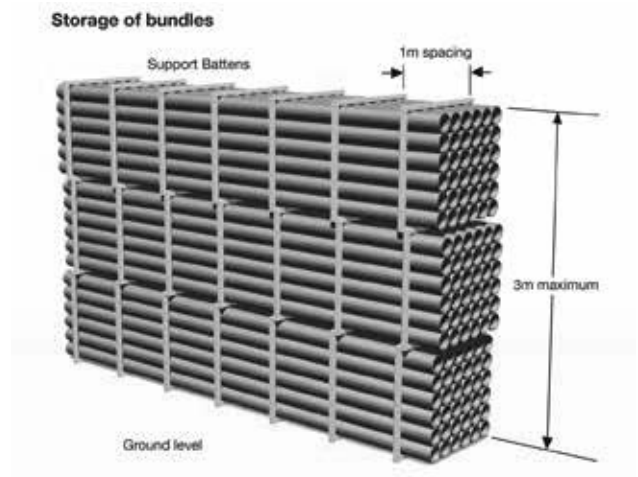

Mechanical, Physical and Electrical Data	Test Method	Value
<b>Mechanical</b>		
Tensile strength at yield (23°C)	ASTM D635	45MN/m <sup>2</sup>
Tensile modulus of elasticity	ASTM D635	2200MN/m <sup>2</sup>
Poissons ratio	-	0.35
Izod impact strength at 23°C (notched)	ASTM D256 (1/8")	35kJ/m <sup>2</sup>
Charpy impact strength at 23°C (notched)	-	20kJ/m <sup>2</sup>
<b>Physical</b>		
Specific gravity	ASTM D792	1.04
Surface roughness factor	-	0.01mm
Softening point (BS2782:Part 1 Method120B:1976)	ISO R 306 (5kg) (heating rate unknown)	99°C
Linear co-efficient of thermal expansion	-	10.1 x 10 <sup>-5</sup> /°C
ISO75 HDT/Ae 1.8Mpa	ASTM D648 (unannealed, 1/4", 18.56 Kgf/cm <sup>2</sup> )	78°C
Thermal conductivity	-	0.157W/m°C
Specific heat	-	2.1kJ/kg.K
Self-ignition temperature	-	540°C
<b>Electrical</b>		
Dielectric constant	-	2.9 at 10 <sup>3</sup> Hz 2.8 at 10 <sup>6</sup> Hz
Volume resistivity IEC 93	-	>1.E <sup>14</sup> ohm m

## Health and Safety at Work Act and COSHH Regulations

Attention is drawn to the requirements in the UK of this Act and to the Control of Substances Hazardous to Health (COSHH) Regulations. Durapipe UK cannot accept responsibility for accidents arising from the misuse of its products because of bad installation or incorrect application.

## Material safety data

Material Safety Data sheets are available at [www.durapipe.co.uk](http://www.durapipe.co.uk)

## Filling and flushing

When purchasing chemicals for either flushing or long-term system use, suppliers should be advised that this is for SuperFLO ABS material. Guidance on the suitability of various system flushing or filling fluids with SuperFLO ABS can be found on the Durapipe website under Technical Support.

Flush in accordance with BSEN 806-4.

## Testing

It is suggested that the following test procedure be followed, after joints have been allowed to dry for the appropriate minimum time (at least 24 hours up to 8"/225mm, sizes 250mm and 315mm require a minimum of 48 hours at 20°C).

The system should be divided conveniently into test sections.

Fill section with cold water making sure that no air pockets remain. Do not pressurise at this stage.

Check system for leaks. If none are apparent, check for and remove any remaining air. Increase pressure up to 3bar. Do not pressurise further at this stage.

Leave section pressurised for 10 minutes. If pressure decays, inspect for leaks and rectify as necessary. If pressure remains constant, slowly increase the hydrostatic pressure to 1½ times nominal operating pressure.

Leave section pressurised for a period not exceeding 1 hour. During this time pressure should not change.

## Caution

Personnel must stand well clear when pressure testing systems.

**Note:** If extended times are required to achieve hydrostatic pressure, either leakage has occurred or air remains in the line. Inspect for leakage and if none is apparent, reduce pressure and check for trapped air. This must be removed before further pressurisation commences.

## Colour

SuperFLO ABS products are a mid-grey colour, generally in accordance with BS5252, colour ref. 18 B 21 and RAL 7001.

## CAD drawings

CAD drawings of Imperial and Metric products contained in this brochure are available on our website [www.durapipe.co.uk](http://www.durapipe.co.uk)

## BIM

3D BIM models for the Durapipe SuperFLO ABS can be downloaded from [www.durapipe.co.uk](http://www.durapipe.co.uk)

## SuperFLO ABS dimensions and standards

### Imperial

The SuperFLO ABS Imperial System is manufactured in accordance with the relevant British Standards as shown below. Kitemark licences are also held, where applicable, for both pipes and fittings. BS 5391 (pipe) BS 5392 (fittings).

### Metric

The SuperFLO ABS Metric System is manufactured generally in accordance with the relevant international standards as shown below:

ISO 15493

KIWA 49 and 549

DIN 8062 and 8063

Threaded fittings conform to the requirements of BS 21/DIN 2999/ISO7. Socket dimensions of SuperFLO ABS Metric fittings for solvent welding comply with ISO/DIS 727-1.

## Materials

SuperFLO ABS material is UK Water Regulations Advisory Scheme approved for cold water services and is listed in the Water Fittings and Materials Directory.

SuperFLO ABS formulation does not contain any harmful metallic stabilisers.

## Gaskets and seals

Gaskets and O-Ring seals are made from EPDM except where stated otherwise.

## Interchangeability

Components in the imperial and metric ranges are not interchangeable, except for 2½"/ 75mm and 5"/140mm.

## Approvals

SuperFLO ABS Imperial series pipe is covered by Kitemark Licence No. KM07961 to BS 5391:Part 1 2006.

SuperFLO ABS Imperial series fittings are covered by Kitemark Licence No. KM07962 to BS 5392:Part 1 2006.

SuperFLO ABS Imperial series pipe and fittings are UK Water Regulations Advisory Scheme approved for cold water services.

SuperFLO ABS Metric series pipe and fittings are UK Water Regulations Advisory Scheme approved for cold water services.

SuperFLO ABS One-step solvent cement is UK Water Regulations Advisory Scheme approved.

SuperFLO ABS Imperial/Metric VKD and VKR ball valves are UK Water Regulations Advisory Scheme approved.

Durapipe Metric pipework is approved for various non-essential services on board ships by:

American Bureau of Shipping

Bureau Veritas

Germanischer Lloyd

Det Norske Veritas

Lloyds register UK

RINA (Royal Institution of Naval Architects)

Russian Marine Register

### Ordering by code

See example below of Durapipe product codes; these should be used when ordering product.

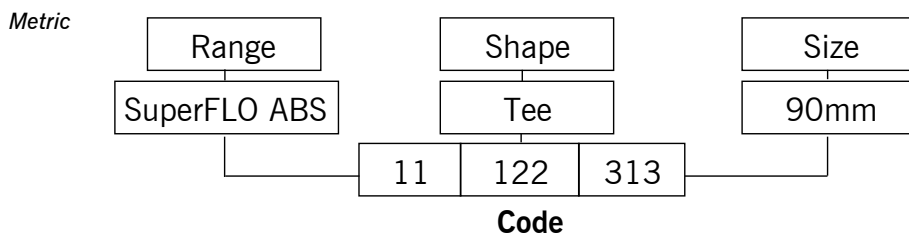
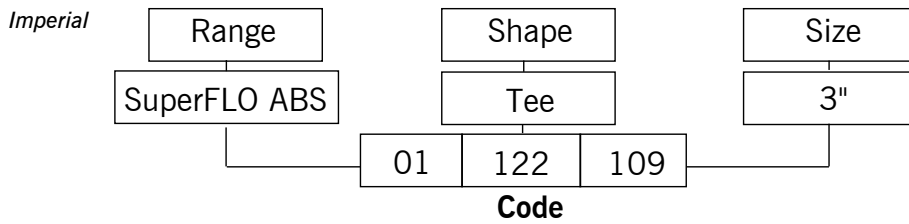

### Abbreviations

The following list of abbreviations is used in this catalogue:

- ABS - Acrylonitrile Butadiene Styrene
- BS - British Standards
- ISO - International Standards Organisation
- DIN - Deutsche Industrie Normen (German Industrial Standards)
- KIWA - Keuringsinstituut Voor Waterleidingartikelen (Netherlands)
- ANSI - American National Standards Institute
- BSP - British Standard Pipe Thread
- EPDM - Ethylene Propylene Rubber
- FPM - Fluorine Rubber (eg. Viton®)
- PTFE - Polytetraflouroethylene (eg. Teflon®)

® Dupont registered trade name.

# Index to SuperFLO ABS Metric Fittings

**Note:** CAD drawings & BIM models available for metric system via [www.durapipe.co.uk](http://www.durapipe.co.uk)



Pipe (plain)  
page 30



Sockets (plain)  
page 30



Reducing bushes  
(plain)  
page 31



Reducing sockets  
(plain)  
page 31



Elbows 45°  
(plain)  
page 31



Elbows 90°  
(plain)  
page 32



Tees 45° (plain)  
page 32



Tees 90° (equal)  
page 32



Tees 90° (swept plain)  
page 33



Tees 90° (reducing  
plain)  
page 33



Bends 90°  
(short radius)  
page 33



Bends 90°  
(long radius)  
page 34



End caps (plain)  
page 34

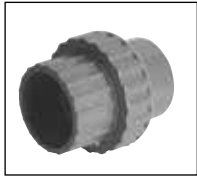

Socket unions (plain)  
page 34



Imperial/metric socket  
adaptors (plain)  
page 35



Male threaded adaptors  
(BSP taper male thread)  
page 35



Female threaded adaptors  
(plain spigot/plain socket/  
female BSP thread)  
page 35



Hose adaptors  
(spigot end/hose tail)  
page 36



Female composite unions  
(plain/brass,  
BSP parallel thread)  
page 36



Male composite unions  
(plain/brass,  
BSP taper thread)  
page 36



Female composite unions  
(plain/stainless steel,  
BSP parallel thread)  
page 37



Male composite unions  
(plain/stainless steel,  
BSP parallel thread)  
page 37



Flexible hoses  
(plain spigot/BSP thread)  
page 38



Wall brackets  
(ABS/brass body)  
page 38



Flanges stub  
(plain serrated)  
page 39



Flanges blanking  
page 39



Backing rings  
(galvanised mild steel)  
page 40

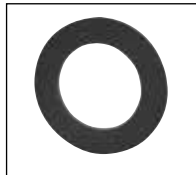

Flat gaskets for use with  
stub flanges  
page 41



Valve support plates  
(galvanised mild steel)  
page 41

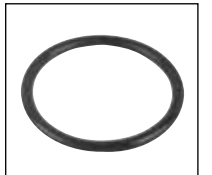

O-Rings  
page 41

## Valves



VKD Double union ball valves (manual – EPDM seals)  
page 42

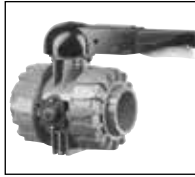

TKD 3-way ball valves  
(manual – EPDM seals)  
page 42



VXE Easyfit double union  
ball valves (manual –  
EPDM seals) page 43



VKR Metering ball valve  
(manual – EPDM seals)  
page 43



SX Easyfit ball check  
valves (EPDM seals)  
page 43



SA Easyfit air release  
valves (EPDM seals)  
page 43



RV Y-Type strainers  
(EPDM seals)  
page 44



Dialock Diaphragm  
valves (manual –  
EPDM seals) page 44



Pressure Loading/Relief  
valves (EPDM seals)  
page 44



FK Butterfly valves  
(glass reinforced  
polypropylene with ABS disc)  
page 45

## Accessories



Cobra pipe clips  
page 46



Rubber lined pipe clips  
page 46



ABS One-step solvent  
cement  
page 46



Eco-cleaner  
page 47



Chamfering and  
de-burring tools  
page 47



Pipe cutters  
page 47



Fibreseal  
page 47

## SuperFLO ABS Pipe metric system Plain PN10

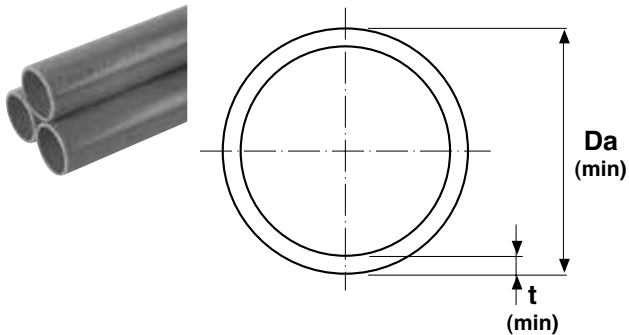

Size	Thickness $t$ mm	Weight kg/m	Length m	Code
16	1.5	0.07	5	11 555 305
20	1.5	0.10	5	11 555 306
25	1.5	0.14	5	11 555 307
32	1.9	0.21	5	11 555 308
40	2.4	0.33	5	11 555 309
50	3.0	0.52	5	11 555 310
63	3.8	0.81	5	11 555 311
75	4.5	1.14	5	11 555 312
90	5.4	1.65	5	11 555 313
110	6.6	2.45	5	11 555 314
125	7.4	3.13	5	11 555 315
140	8.3	3.97	5	11 555 316
160	9.5	5.13	5	11 555 317
200	11.9	8.06	5	11 555 318
225	13.4	10.17	5	11 555 319
250	14.8	12.31	5	11 555 320
*315	18.7	20.00	5	11 555 323

16	1.5	0.07	6	11 551 305
20	1.5	0.10	6	11 551 306
25	1.5	0.14	6	11 551 307
32	1.9	0.21	6	11 551 308
40	2.4	0.33	6	11 551 309
50	3.0	0.52	6	11 551 310
63	3.8	0.81	6	11 551 311
75	4.5	1.14	6	11 551 312
90	5.4	1.65	6	11 551 313
110	6.6	2.45	6	11 551 314
125	7.4	3.13	6	11 551 315
140	8.3	3.97	6	11 551 316
160	9.5	5.13	6	11 551 317
200	11.9	8.06	6	11 551 318
225	13.4	10.17	6	11 551 319
250	14.8	12.31	6	11 551 320
*315	18.7	20.00	6	11 551 323

\*315 is PN8 rated.

## Sockets Plain

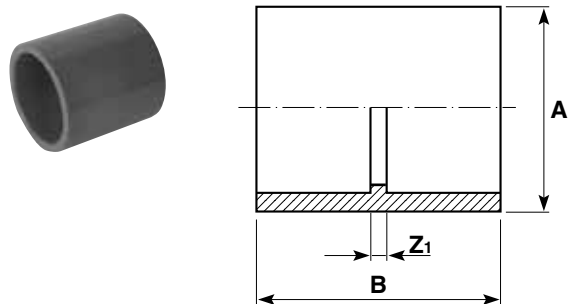

Size	PN	A	B	$Z_1$	gms	Code
16	10	21	31	3	5	11 100 305
20	10	25	37	3	7	11 100 306
25	10	31	42	2	12	11 100 307
32	10	41	49	3	25	11 100 308
40	10	50	58	4	45	11 100 309
50	10	62	68	4	77	11 100 310
63	10	78	81	4	154	11 100 311
75	10	88	93	3	230	11 100 312
90	10	107	108	4	380	11 100 313
110	10	126	131	7	690	11 100 314
125	10	146	149	7	1040	11 100 315
140	10	171	163	7	1390	11 100 316
160	10	182	184	8	1660	11 100 317
200	10	223	220	8	2390	11 100 318
225	10	260	250	11	3470	11 100 319
250	10	286	272	10	5760	11 100 320
315	8	355	339	11	9780	11 100 323

## Reducing bushes Plain

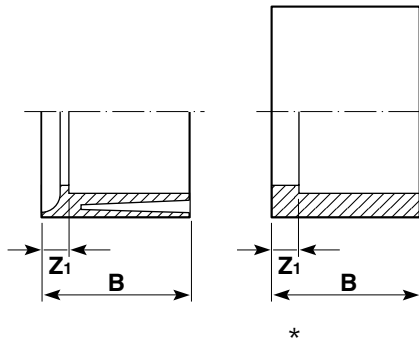
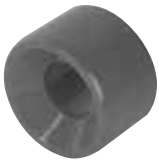

Size	PN	B	Z <sub>1</sub>	gms	Code
20 x 16	10	17	3	2	11 109 412
25 x 20	10	19	3	4	11 109 415
32 x 16	10	23	9	5	11 109 417
32 x 25	10	23	8	6	11 109 419
40 x 32	10	28	6	13	11 109 423
50 x 20*	10	33	17	32	11 109 424
50 x 25*	10	33	13	29	11 109 425
50 x 32*	10	32	11	60	11 109 426
50 x 40	10	32	5	40	11 109 427
63 x 25*	10	39	20	60	11 109 429
63 x 32*	10	39	16	60	11 109 430
63 x 50	10	39	7	70	11 109 432
75 x 63	10	46	7	80	11 109 438
90 x 50*	10	54	23	210	11 109 442
90 x 63*	10	54	15	224	11 109 443
90 x 75	10	55	9	150	11 109 444
110 x 63*	10	64	25	252	11 109 449
110 x 90	10	64	10	270	11 109 451
125 x 110	10	72	9	280	11 109 459
140 x 125	10	79	8	300	11 109 467
160 x 90*	10	89	35	320	11 109 473
160 x 110*	10	89	27	660	11 109 474
160 x 140	10	89	10	700	11 109 476
200 x 160	10	110	21	1560	11 109 487
225 x 160*	10	122	33	1600	11 109 495
225 x 200*	10	122	13	1660	11 109 496
250 x 225*	10	132	12	2230	11 109 499
315 x 250*	8	165	33	4220	11 109 503

\*Configuration shown in inset.

## Reducing sockets Plain

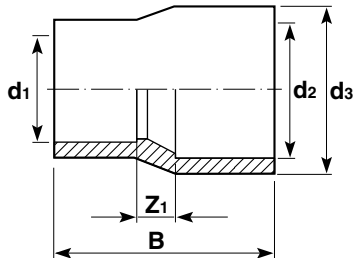

PN	d <sub>3</sub>	d <sub>2</sub>	d <sub>1</sub>	B	Z <sub>1</sub>	gms	Code
10	25	20	16	37	6	6	11 114 412
10	32	25	20	42	6	12	11 114 415
10	40	32	25	50	8	22	11 114 419
10	50	40	32	60	11	39	11 114 423
10	63	50	40	71	11	80	11 114 427
10	75	63	50	85	14	108	11 114 432
10	90	75	63	98	13	190	11 114 438
10	110	90	75	115	16	350	11 114 444
10	125	110	90	140	21	480	11 114 451
10	140	125	110	156	20	690	11 114 459
10	160	140	125	170	20	1000	11 114 467
10	200	160	140	193	23	2180	11 114 476
10	225	200	160	237	41	2530	11 114 487

## Elbows 45° Plain

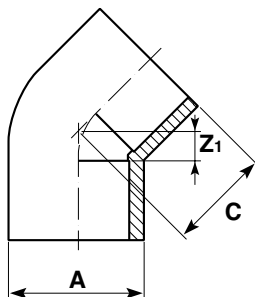

Size	PN	A	C	Z <sub>1</sub>	gms	Code
16	10	21	20	5	5	11 119 305
20	10	25	22	5	7	11 119 306
25	10	31	26	7	14	11 119 307
32	10	40	31	8	27	11 119 308
40	10	50	37	10	54	11 119 309
50	10	62	45	13	100	11 119 310
63	10	82	54	16	180	11 119 311
75	10	90	63	17	300	11 119 312
90	10	112	70	18	550	11 119 313
110	10	137	90	27	950	11 119 314
125	10	155	103	31	1350	11 119 315
140	10	173	115	37	1980	11 119 316
160	10	190	125	35	2920	11 119 317
200	10	235	149	43	3460	11 119 318
225	10	262	167	46	4920	11 119 319
250	10	286	189	58	5900	11 119 320
315	8	359	230	66	11880	11 119 323

## Elbows 90° Plain

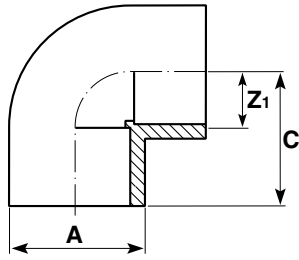

Size	PN	A	C	Z <sub>1</sub>	gms	Code
16	10	20	24	10	6	11 115 305
20	10	25	28	11	10	11 115 306
25	10	31	34	15	17	11 115 307
32	10	40	41	18	35	11 115 308
40	10	50	47	20	68	11 115 309
50	10	62	59	26	129	11 115 310
63	10	78	71	31	230	11 115 311
75	10	90	83	38	385	11 115 312
90	10	112	100	49	690	11 115 313
110	10	136	125	63	1220	11 115 314
125	10	155	140	63	1720	11 115 315
140	10	173	153	76	2390	11 115 316
160	10	190	172	79	3600	11 115 317
200	10	235	207	110	4300	11 115 318
225	10	261	240	119	6550	11 115 319
250	10	286	319	188	9560	11 115 320
315	8	359	400	236	17910	11 115 323

## Tees 45° Plain

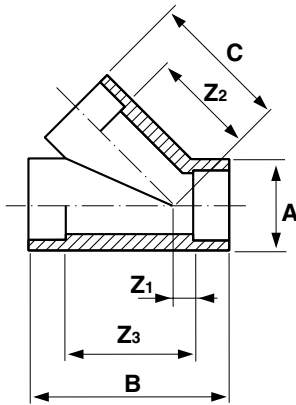

Size	PN	A	B	C	Z <sub>1</sub>	Z <sub>2</sub>	Z <sub>3</sub>	gms	Code
20	10	28	68	43	6	26	34	30	11 418 306
25	10	33	81	52	7	29	55	45	11 418 307
32	10	41	98	65	9	42	52	80	11 418 308
40	10	50	117	77	11	51	65	135	11 418 309
50	10	60	140	95	12	63	78	195	11 418 310
63	10	74	169	114	13	76	93	410	11 418 311

## Tees 90° Equal

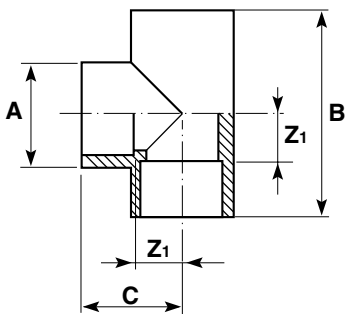

Size	PN	A	B	C	Z <sub>1</sub>	gms	Code
16	10	21	47	25	10	7	11 122 305
20	10	25	57	30	12	12	11 122 306
25	10	31	67	34	15	24	11 122 307
32	10	40	81	43	18	48	11 122 308
40	10	50	99	50	23	87	11 122 309
50	10	62	119	62	28	160	11 122 310
63	10	78	146	70	34	300	11 122 311
75	10	90	172	87	36	510	11 122 312
90	10	112	205	104	46	900	11 122 313
110	10	132	248	128	60	1650	11 122 314
125	10	154	276	143	67	2300	11 122 315
140	10	172	307	153	72	3200	11 122 316
160	10	191	343	172	86	4800	11 122 317
200	10	237	413	206	101	5800	11 122 318
225	10	262	482	240	120	7700	11 122 319
250	10	286	518	259	128	10160	11 122 320
315	8	360	652	326	162	19390	11 122 323



## Tees 90° Swept plain

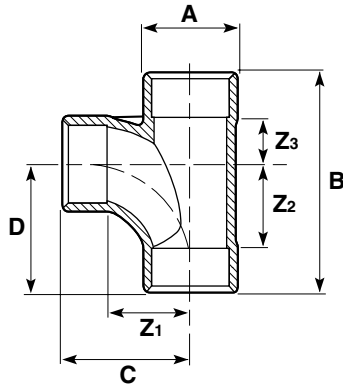

Size	PN	A	B	C	D	Z <sub>1</sub>	Z <sub>2</sub>	Z <sub>3</sub>	gms	Code
32	10	41	115	79	79	57	57	14	90	11 148 308
50	10	62	160	105	105	74	74	24	259	11 148 310
63	10	78	195	125	125	87	87	32	480	11 148 311
75	10	92	210	125	125	81	81	41	601	01 148 108
110	10	139	315	190	190	127	127	62	2235	11 148 314

## Tees 90° Reducing plain

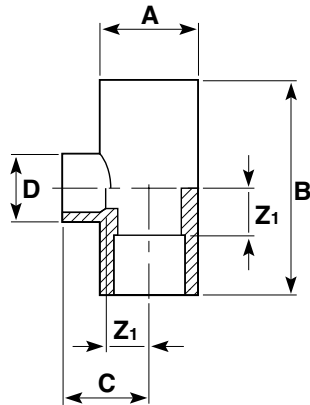

Size	PN	A	B	C	D	Z <sub>1</sub>	gms	Code
25 x 20	10	31	67	31	25	14	22	11 124 415
32 x 20	10	40	81	35	25	18	40	11 124 418
32 x 25	10	40	81	37	31	18	41	11 124 419
40 x 20	10	50	98	39	25	22	72	11 124 421
40 x 25	10	50	98	41	31	22	72	11 124 422
50 x 20	10	62	119	44	29	27	104	11 124 424
50 x 25	10	62	119	46	31	27	140	11 124 425
50 x 32	10	62	119	50	40	27	140	11 124 426
63 x 25	10	78	146	53	31	34	250	11 124 429
63 x 32	10	78	146	57	40	34	250	11 124 430
75 x 32	10	91	168	62	41	40	391	11 124 435
75 x 40	10	91	168	66	50	40	398	11 124 436
75 x 50	10	91	168	71	61	40	406	11 124 437
75 x 63	10	91	168	78	76	40	428	11 124 438
90 x 40	10	109	198	74	50	48	642	11 124 441
90 x 50	10	109	198	79	61	48	649	11 124 442
90 x 63	10	109	198	86	76	48	664	11 124 443
90 x 75	10	109	198	92	91	48	693	11 124 444
110 x 50	10	133	244	92	61	61	1165	11 124 448
110 x 63	10	133	244	99	76	61	1173	11 124 449
110 x 75	10	133	244	105	91	61	1188	11 124 450
110 x 90	10	133	244	112	109	61	1210	11 124 451

## Bends 90° Short radius

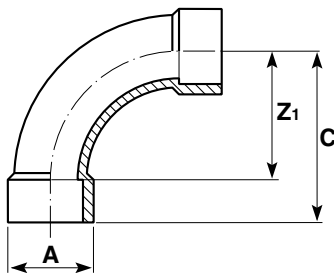

Size	PN	A	C	Z <sub>1</sub>	gms	Code
20	10	26	57	40	18	11 118 306
25	10	33	69	50	38	11 118 307
32	10	41	87	64	75	11 118 308
40	10	51	107	80	135	11 118 309
50	10	62	132	100	245	11 118 310
63	10	78	165	126	470	11 118 311
75	10	93	195	150	810	11 118 312
90	10	111	234	180	1350	11 118 313
110	10	140	284	220	2570	11 118 314

## Bends 90° Long radius

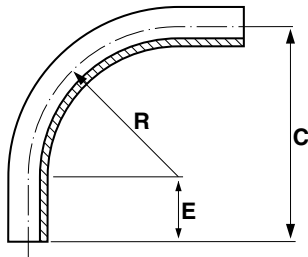

Size	C	E	R	gms	Code
125	750	250	500	4790	11 309 315
140	840	280	560	6700	11 309 316
160	960	320	640	10040	11 309 317
200	1200	400	800	19480	11 309 318
225	1350	450	900	27850	11 309 319

## End caps Plain

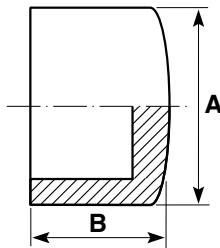

Size	PN	A	B	Weight gms	Code
16	10	21	16	3	11 149 305
20	10	25	21	5	11 149 306
25	10	31	24	8	11 149 307
32	10	41	30	19	11 149 308
40	10	50	35	30	11 149 309
50	10	62	41	53	11 149 310
63	10	78	50	106	11 149 311
75	10	94	59	180	11 149 312
90	10	112	70	300	11 149 313
110	10	136	84	570	11 149 314

## Socket unions Plain

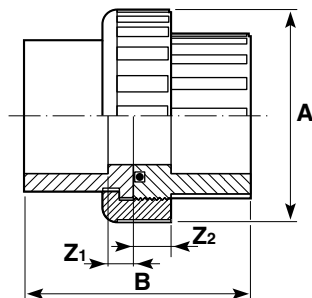

Size	PN	A	B	Z <sub>1</sub>	Z <sub>2</sub>	Weight gms	Code
16	10	34	42	3	10	19	11 205 305
20	10	40	47	3	10	29	11 205 306
25	10	50	53	3	10	46	11 205 307
32	10	57	64	8	11	70	11 205 308
40	10	73	78	10	13	140	11 205 309
50	10	80	92	13	15	154	11 205 310
63	10	102	111	14	20	270	11 205 311
75	10	135	107	8	13	720	11 205 312
90	10	157	115	7	4	750	11 205 313
110	10	183	138	8	7	1115	11 205 314

EPDM seal as standard.  
For FPM seal order 11 204 3\*\*

## Imperial/metric socket adaptors Plain

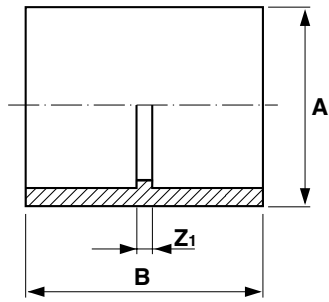

Size	PN	A	B	Z <sub>1</sub>	Weight gms	Code
*1/2 - 20	10	26	37	3	11	11 345 102
*3/4 - 25	10	31	41	3	23	11 345 103
*1 - 32	10	40	49	3	40	11 345 104
*1 1/4 - 40	10	50	58	2	80	11 345 105
*1 1/2 - 50	10	59	67	3	160	11 345 106
*2 - 63	10	74	78	2	230	11 345 107
*3 - 90	10	107	105	3	340	11 345 109
*4 - 110	10	134	130	6	675	11 345 110
*6 - 160	10	195	183	8	1890	11 345 112

\*Sizes shown in imperial n.b. designation.

## Male threaded adaptors BSP taper male thread

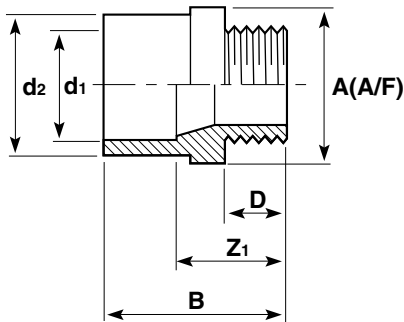

Size d <sub>2</sub> d <sub>1</sub>	PN	T*	A	B	D	Z <sub>1</sub>	Weight gms	Code
16- 12-	10	3/8	19	35	11	22	7	11 151 331
20- 16-	10	3/8	24	38	12	24	7	11 151 332
20- 16-	10	1/2	24	42	15	28	7	11 151 333
20- 16-	10	3/4	30	46	16	28	8	11 151 327
25- 20-	10	1/2	30	46	15	28	13	11 151 334
25- 20-	10	3/4	30	48	16	31	14	11 151 335
32- 25-	10	1/2	36	51	15	32	23	11 151 352
32- 25-	10	3/4	36	52	16	33	23	11 151 336
32- 25-	10	1	36	55	19	36	23	11 151 337
40- 32-	10	1	46	58	20	36	36	11 151 338
40- 32-	10	1 1/4	46	60	21	37	38	11 151 339
50- 40-	10	1 1/4	55	66	22	39	70	11 151 340
50- 40-	10	1 1/2	55	66	21	39	70	11 151 341
63- 50-	10	1 1/2	72	73	22	41	115	11 151 342
63- 50-	10	2	72	78	26	46	123	11 151 343
75- 63-	10	2	80	84	26	46	150	11 151 345

\*Thread size designation.

## Female threaded adaptors Plain spigot/plain socket/female BSP thread

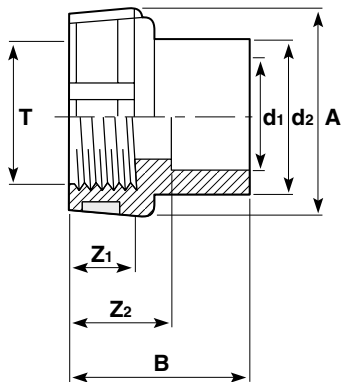

Size d <sub>2</sub> d <sub>1</sub>	PN	T*	A	B	Z <sub>1</sub>	Z <sub>2</sub>	Weight gms	Code
16- 12-	10	3/8	24	28	11	16	7	11 153 331
20- 16-	10	1/2	30	35	15	21	14	11 153 333
25- 20-	10	3/4	38	39	16	22	21	11 153 335
32- 25-	10	1	45	45	18	26	42	11 153 337
40- 32-	10	1 1/4	56	54	21	31	69	11 153 339
50- 40-	10	1 1/2	64	60	21	33	108	11 153 341
63- 50-	10	2	78	72	25	41	169	11 153 343

\*Thread size designation.

## Hose adaptors Spigot end/hose tail

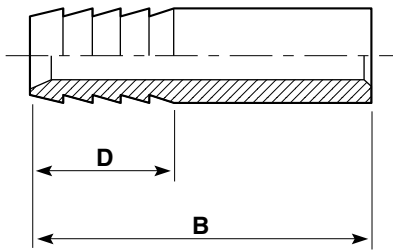

Size	PN	B	D	Weight gms	Code
16	10	60	25	8	11 158 305
20	10	75	30	13	11 158 306
25	10	80	35	20	11 158 307
32	10	90	40	32	11 158 308

## Female composite unions Plain/brass, female BSP parallel thread

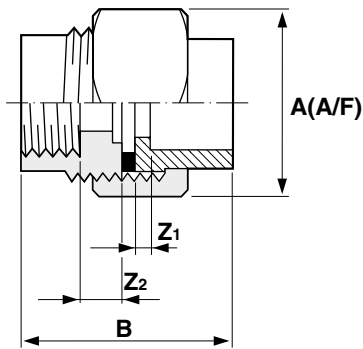

Size	PN	A	B	Z <sub>1</sub>	Z <sub>2</sub>	Weight gms	Code
16 x 3/8*	10	32	37	3	7	105	11 216 305
20 x 1/2*	10	40	43	3	7	175	11 216 306
25 x 3/4*	10	48	47	3	7	320	11 216 307
32 x 1*	10	55	59	8	9	420	11 216 308
40 x 1 1/4*	10	65	68	10	8	620	11 216 309
50 x 1 1/2*	10	78	76	12	9	1000	11 216 310
63 x 2*	10	88	89	12	11	1200	11 216 311

\*Thread sizes designation.

Fitted with brass retaining nut and EPDM rubber seal.

Brass material to BS2872, WRAS approved.

**ALL** Durapipe Brass Components are manufactured using DZR Brass.

## Male composite unions Plain/brass, male BSP taper thread

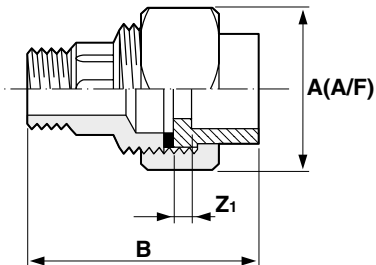

Size	PN	A	B	Z <sub>1</sub>	Z <sub>2</sub>	Weight gms	Code
16 x 3/8*	10	32	48	3	9	100	11 217 305
20 x 1/2*	10	40	54	3	9	165	11 217 306
25 x 3/4*	10	48	74	3	10	250	11 217 307
32 x 1*	10	55	86	8	11	310	11 217 308
40 x 1 1/4*	10	65	94	10	11	450	11 217 309
50 x 1 1/2*	10	78	108	12	12	800	11 217 310
63 x 2*	10	88	126	12	14	950	11 217 311

\*Thread sizes designation.

Fitted with brass retaining nut and EPDM rubber seal.

Brass material to BS2872, WRAS approved.

**ALL** Durapipe Brass Components are manufactured using DZR Brass.

## Female composite unions Plain/stainless steel, female BSP parallel thread

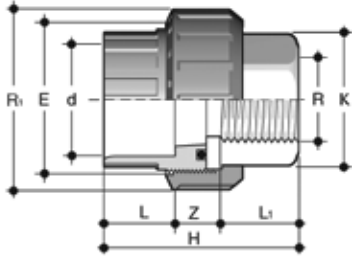

Size	PN	E	H	K	Z	Weight gms	Code
16mm x 3/8"*	10	33	45.5	20	18	50	11 218 305
20mm x 1/2"*	10	41	48.5	25	16	81	11 218 306
25mm x 3/4"*	10	50	54.5	32	17	152	11 218 307
32mm x 1"*	10	58	59.5	38	18	170	11 218 308
40mm x 1 1/4"*	10	72	68.5	48	21	353	11 218 309
50mm x 1 1/2"*	10	79	84.5	55	30.5	435	11 218 310
63mm x 2"*	10	98	94.5	69	29.5	779	11 218 311

\*Thread sizes designation.

**ALL Durapipe Stainless Steel Components are manufactured using 316L Grade Stainless Steel.**

## Male composite unions Plain/stainless steel, male BSP parallel thread

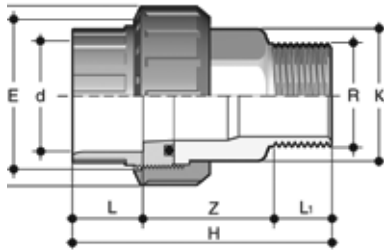

Size	PN	E	H	K	Z	Weight gms	Code
16 x 3/8"*	10	33	58.5	20	34	74	11 219 305
20 x 1/2"*	10	41	65	25	35.5	123	11 219 306
25 x 3/4"*	10	50	72.5	32	38.5	215	11 219 307
32 x 1"*	10	58	80	38	40.5	269	11 219 308
40 x 1 1/4"*	10	72	91	48	45.5	516	11 219 309
50 x 1 1/2"*	10	79	101	55	50.5	639	11 219 310
63 x 2"*	10	98	122.5	69	60.5	1111	11 219 311

\*Thread sizes designation.

**ALL Durapipe Stainless Steel Components are manufactured using 316L Grade Stainless Steel.**

## Flexible hoses Plain spigot, BSP thread



Size	Code
20 x 1/2" x 300	11450306
25 x 3/4" x 300	11450307
32 x 1" x 300	11450308
20 x 1/2" x 600	11451306
25 x 3/4" x 600	11451307
32 x 1" x 600	11451308

10 bar working pressure at 20 C.

Other lengths available on request.

**ALL Durapipe Brass Components are manufactured using DZR Brass.**

Product is approved to BSRIA BG4-2004

## Wall brackets ABS/brass body

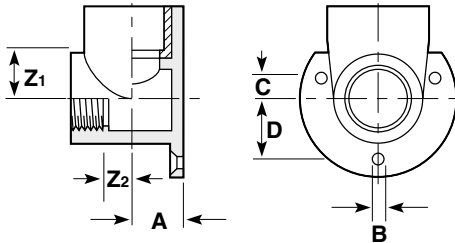

Size	PN	A	B	C	D	Z <sub>1</sub>	Z <sub>2</sub>	Weight gms	Code
16- 3/8*	10	15	4.5	6	19	17	9	180	31 422 326
20- 1/2*	10	16.5	4.5	6	19	18	9	185	31 422 327
25- 1/2*	10	20	4.5	5	24	19	11	215	31 422 328
25- 3/4*	10	20	4.5	5	24	19	11	200	31 422 329

\*Thread sizes designation.

**ALL Durapipe Brass Components are manufactured using DZR Brass.**

## Flanges stub Plain serrated

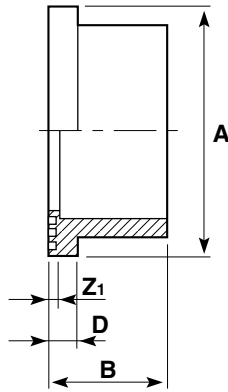

Size	PN	A	B	D	Z <sub>1</sub>	Weight gms	Code
16	10	29	17	6	3	5	11 135 305
20	10	34	20	6	3	8	11 135 306
25	10	41	22	7	3	13	11 135 307
32	10	50	26	7	3	19	11 135 308
40	10	61	30	8	3	36	11 135 309
50	10	73	35	8	3	60	11 135 310
63	10	90	42	9	4	100	11 135 311
75	10	106	49	10	4	150	11 135 312
90	10	125	59	11	6	240	11 135 313
110	10	149	68	12	6	370	11 135 314
125	10	165	76	13	5	520	11 135 315
140	10	180	83	14	7	680	11 135 316
160	10	205	93	16	5	930	11 135 317
200*	10	252	114	17	6	1300	11 135 318
225	10	273	126	24	6	1470	11 135 319
250	10	306	140	20	9	2140	11 135 320
315	10	375	180	32	14	5000	11 135 323

\*The 200mm (NW175) stub flange supplied by Durapipe when used in conjunction with backing ring; code number 421 318 and 420 318 has a bolt circle diameter which matches 225mm (NW200) flanges (295mm PCD).

## Flanges blanking

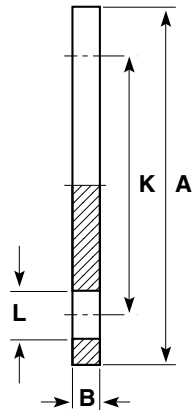

### DIN 2501 16 bar/PN16

Size	PN	A	B	K	L	No. Holes	Weight gms	Code
32	10	116	13	85	14	4	139	11 323 308
40	10	141	13	100	18	4	204	11 323 309
50	10	153	13	110	18.5	4	237	11 323 310
63	10	166	19	124	18	4	447	11 323 311
75	10	186	19	145	18.5	4	568	11 323 312
90	10	201	19	159	18	8	645	11 323 313
110	10	221	26	180	18	8	715	11 323 314
125	10	251	26	210	18	8	1338	11 323 315
140	10	251	26	210	18	8	1338	11 323 316
160	10	286	27	240	23	8	1720	11 323 317

**Note:** Durapipe backing rings must be used in conjunction with blank flanges.

## Backing rings Galvanised mild steel

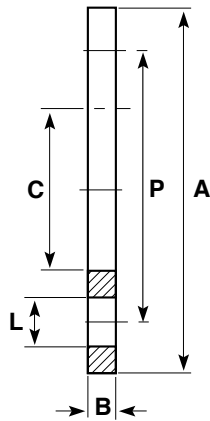

### Drilled to DIN 2501 (BS4504) PN10/PN16

Size	A	B	C	P	L	No. Holes	Weight gms	Code
16	90	7	23	61	14	4	240	13 421 305
20	96	6	28	65	14	4	300	13 421 306
25	106	7	34	75	14	4	320	13 421 307
32	116	7	42	85	14	4	350	13 421 308
40	142	7	51	100	18	4	420	13 421 309
50	152	7	62	110	18	4	710	13 421 310
63	165	8	78	125	18	4	1010	13 421 311
75	186	9	92	145	18	4	1280	13 421 312
90	201	9	110	160	18	8	1380	13 421 313
110	220	9	133	180	18	8	1430	13 421 314
125	253	8	150	210	18	8	1960	13 421 315
140	251	11	167	210	18	8	2060	13 421 316
160	286	11	190	240	22	8	2700	13 421 317

### Drilled to DIN 2501 (BS4504) PN10

Size	A	B	C	P	L	No. Holes	Weight gms	Code
200*	340	11	235	295	22	8	3190	13 421 318
225	340	11	249	295	22	8	3540	13 421 319
250	396	20	278	350	22	12	7330	13 421 320
315	448	20	355	402	22	12	9900	13 421 323

### Drilled to DIN 2501 (BS4504) PN16

Size	A	B	C	P	L	No. Holes	Weight gms	Code
200*	340	11	235	295	22	12	3190	13 420 318
225	340	11	249	295	22	12	3540	13 420 319
250	405	20	278	355	26	12	7330	13 420 320
315	460	20	355	410	26	12	9900	13 420 323

### Drilled to ANSI CLASS 150

Size	A	B	C	P	L	No. Holes	Weight gms	Code
20	90	8	28	61	16	4	300	13 448 306
25	100	8	34	70	16	4	380	13 448 307
32	110	9	42	79	16	4	480	13 448 308
40	118	8	51	90	16	4	530	13 448 309
50	129	8	63	99	16	4	590	13 448 310
63	154	10	78	121	19	4	1050	13 448 311
90	192	11	110	153	19	4	1470	13 448 313
110	230	11	133	190	19	8	2080	13 448 314

\*The 200mm (NW175) stub flange supplied by Durapipe when used in conjunction with backing ring; code number 421 318 and 420 318 has a bolt circle diameter which matches 225mm (NW200) flanges (295mm PCD).



## Flat gaskets for use with stub flanges

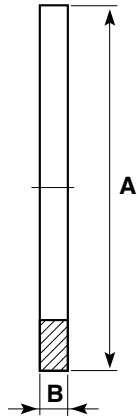

Size	A	B	Weight gms	EPDM Code
16	29	3.0	2	13 411 305
20	34	3.5	2	13 411 306
25	41	3.5	3	13 411 307
32	50	3.0	4	13 411 308
40	60	3.0	4	13 411 309
50	72	3.3	5	13 411 310
63	90	4.0	10	13 411 311
75	106	3.0	20	13 411 312
90	125	3.1	30	13 411 313
110	150	4.0	40	13 411 314
125	166	4.0	50	13 411 315
140	180	4.0	60	13 411 316
160	205	4.0	70	13 411 317
200	253	4.0	120	13 411 318
225	274	3.8	165	13 411 319
250	306	4.0	170	13 431 320
280	330	4.0	190	13 411 321
315	379	4.2	220	13 411 323

## Valve support plates Galvanised steel

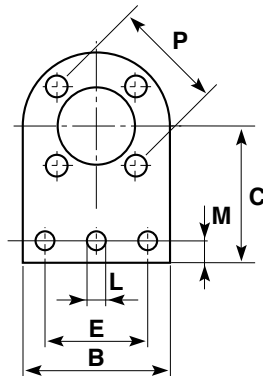

### DIN 2501 16 bar/PN16

Size	B	C	E	L	M	N	P	No. Holes	Weight gms	Code
16	91	84	50	14	16	2	61	4	370	31 459 305
20	97	86	49	14	16	2	65	4	640	31 459 306
25	105	89	76	14	16	2	75	4	750	31 459 307
32	114	96	77	14	12	2	85	4	860	31 459 308
50	150	125	100	14	22	2	110	4	1480	31 459 310
63	160	134	100	14	24	2	125	4	2100	31 459 311
75	185	144	125	14	22	2	145	4	2500	31 459 312
90	203	150	127	14	23	2	160	8	2660	31 459 313
110	214	160	150	14	22	3	179	8	2960	31 459 314

N = No. of holes in base.

## O-Rings EPDM/FPM

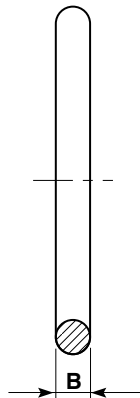

Size	ID	B	Weight gms	EPDM Code	FPM Code
16	15.54	2.62	23	13 209 305	03 211 305
20	20.22	3.53	39	13 209 306	03 211 306
25	28.17	3.53	68	13 209 307	03 211 307
32	32.93	3.53	94	13 209 308	03 211 308
40	40.65	5.34	163	13 209 309	03 211 105
50	47.00	5.34	190	13 209 310	03 211 106
63	59.69	5.34	355	03 306 107	03 211 107

# Valves

Premium Quality  
Valve for Demanding  
Environments

## VKD Double union ball valves Manual – EPDM seals

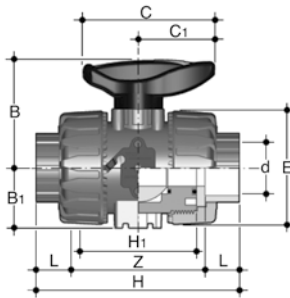

d	DN	PN	L	Z	H	E	B	C	Weight gms	Code
16	10	16	14	75	103	55	49	66	160	HO DKA 305
20	15	16	16	71	103	55	49	66	160	HO DKA 306
25	20	16	19	77	115	66	59	75	265	HO DKA 307
32	25	16	22	84	128	75	66	85	345	HO DKA 308
40	32	16	26	94	146	87	75	97	550	HO DKA 309
50	40	16	31	102	164	100	87	110	730	HO DKA 310
63	50	16	38	123	199	122	101	134	1280	HO DKA 311

Options:

FPM seals (plain ends) order HO DKB \*\*\*

For threaded versions refer to Imperial Valves section.

Manual valves can be supplied with locking kits - further information is available from our Valve Department.

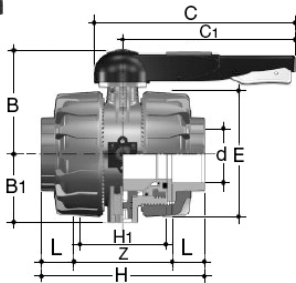

d	DN	PN	Z	L	H	H <sub>1</sub>	E	B	B <sub>1</sub>	C	C <sub>1</sub>	gms	Code
75	65	16	147	44	235	133	164	164	87	225	175	3725	HO DKA 312
90	80	16	168	51	270	149	203	177	105	327	272	5700	HO DKA 313
110	100	16	186	61	308	167	238	195	129	385	330	8660	HO DKA 314

Options:

FPM seals (plain ends) order HO DKB\*\*\*

Premium Quality  
Valve for Demanding  
Environments

## TKD 3-way ball valves Manual – EPDM seals

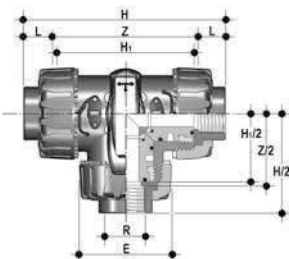
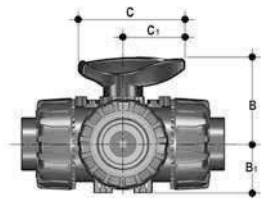

T-Port configuration

d	DN	PN	H	Z	C	C <sub>1</sub>	B	B <sub>1</sub>	gms	Code
20	15	16	118	86	67	40	54	29	235	HO TTA 306
25	20	16	145	107	85	49	65	34.5	415	HO TTA 307
32	25	16	160	116	85	49	65.9	39	570	HO TTA 308
40	32	16	188.5	136.5	108	64	82.5	46	875	HO TTA 309
50	40	16	219	157	108	64	89	52	1250	HO TTA 310
63	50	16	266.5	190.5	134	76	108	62	2225	HO TTA 311

Options:

FPM seals (plain ends) order HO TTB\*\*\*

FPM seals (threaded ends) order HO TTB\*\*\*

Manual valves can be supplied with locking kits - further information is available from our Valve Department.

L-Port configuration

d	DN	PN	H	Z	C	C <sub>1</sub>	B	B <sub>1</sub>	gms	Code
20	15	16	118	86	67	40	54	29	235	HO LTA 306
25	20	16	145	107	85	49	65	34.5	415	HO LTA 307
32	25	16	160	116	85	49	65.9	39	570	HO LTA 308
40	32	16	188.5	136.5	108	64	82.5	46	875	HO LTA 309
50	40	16	219	157	108	64	89	52	1250	HO LTA 310
63	50	16	266.5	190.5	134	76	108	62	2225	HO LTA 311

Options:

FPM seals (plain ends) order HO LTB\*\*\*

## VXE Easyfit double union ball valves Manual – EPDM seals

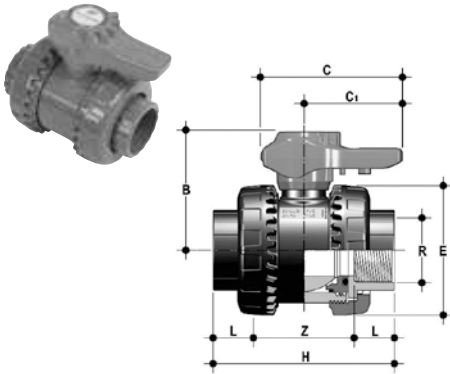

d	DN	PN	L	Z	H	E	B	C	C <sub>1</sub>	gms	Code
16	10	16	14	54	82	54	49	64	20	175	HO XEA 305
20	15	16	16.5	49	82	54	49	64	20	175	HO XEA 306
25	20	16	19	53	91	63	62	78	23	252	HO XEA 307
32	25	16	22.5	58	103	72	71	87	27	354	HO XEA 308
40	32	16	26	68	120	85	82	102	30	548	HO XEA 309
50	40	16	30	79	139	100	92	109	33	771	HO XEA 310
63	50	16	36	102	174	118	110	133	39	1285	HO XEA 311

Options:

FPM seals (plain ends) order HO XEB \*\*\*  
For threaded versions refer to Imperial Valves section.

**NEW**

## VKR Metering ball valves Manual – EPDM seals

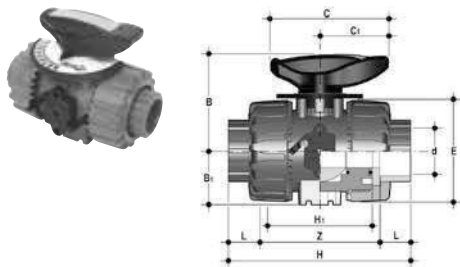

d	DN	PN	L	Z	H	H <sub>1</sub>	E	B	B <sub>1</sub>	C	C <sub>1</sub>	gms	Code
16	10	16	16	71	103	65	54	54	29	67	40	215	HO MBA 305
20	15	16	16	71	103	65	54	54	29	67	40	215	HO MBA 306
25	20	16	19	77	115	70	65	65	34.5	85	49	330	HO MBA 307
32	25	16	22	84	128	78	73	70	39	85	49	438	HO MBA 308
40	32	16	26	94	146	88	86	83	46	108	64	493	HO MBA 309
50	40	16	31	102	164	91	98	89	52	108	64	925	HO MBA 310
63	50	16	38	123	199	111	122	108	62	134	76	1577	HO MBA 311

Options:

FPM seals (plain ends) order HO MBB \*\*\*

## SX Easyfit ball check valves EPDM seals

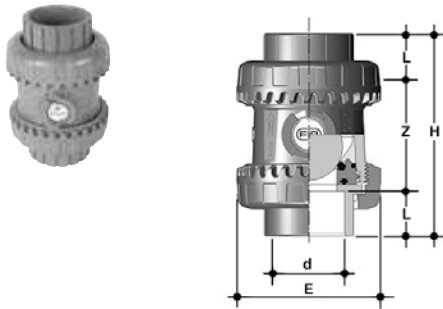

d	DN	PN	L	Z	H	E	gms	Code
16	10	16	14	54	82	54	145	HO SXA 305
20	15	16	16.5	50	82	54	148	HO SXA 306
25	20	16	19	53	91	63	190	HO SXA 307
32	25	16	22.5	59	103	72	300	HO SXA 308
40	32	16	26	68	120	85	460	HO SXA 309
50	40	16	30	77	139	100	675	HO SXA 310
63	50	16	36	98	174	118	1080	HO SXA 311

Options:

FPM seals (plain ends) order HO SXB\*\*\*  
For threaded versions refer to Imperial Valves section.

**Note:** this valve must be installed at a minimum distance of 10 x nominal diameter (eg. 20" for size 63mm) from pump flange.

## SA Easyfit air release valves EPDM seals

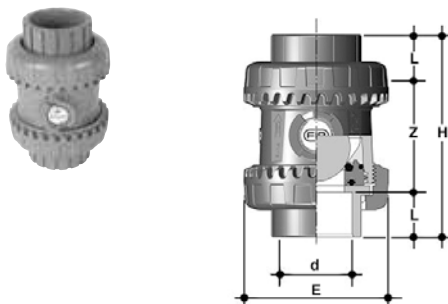

d	DN	PN	L	Z	H	E	gms	Code
20	15	16	16.5	50	82	54	148	HO SAA 306
25	20	16	19	53	91	63	190	HO SAA 307
32	25	16	22.5	59	103	72	300	HO SAA 308
40	32	16	26	68	120	85	460	HO SAA 309
50	40	16	30	77	139	100	675	HO SAA 310
63	50	16	36	98	174	118	1080	HO SAA 311

Options:

FPM seals (plain ends) order HO SAB\*\*\*  
For threaded versions refer to Imperial Valves section.

## RV Y-Type strainers Plain ends – EPDM seals

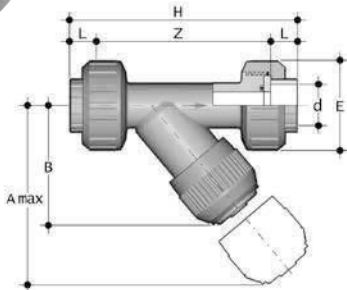

D	DN	PN	A	B	E	L	Z	H	Fig.	gms	Code
20	15	16	125	72	55	16	103	135	A	211	HO UVA 306
25	20	16	145	84	66	19	120	158	A	358	HO UVA 307
32	25	16	165	95	75	22	132	176	A	526	HO UVA 308
40	32	16	190	111	87	26	155	207	A	733	HO UVA 309
50	40	16	210	120	100	31	181	243	A	1095	HO UVA 310
63	50	10	240	139	120	38	222	298	A	1843	HO UVA 311

Options:

FPM seals (plain ends) order HO UVB \*\*\*

For threaded versions refer to Imperial Valves section.

## Dialock® diaphragm valves Manual – plain union ends – EPDM seals

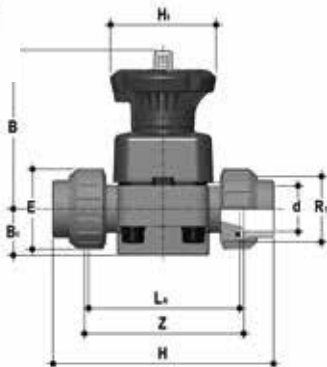

d	DN	PN	B	B <sub>1</sub>	E	H	H <sub>1</sub>	L <sub>A</sub>	Z	gms	Code
20	15	10	102	25	41	143	80	90	98	420	HO DVA 306
25	20	10	105	30	50	167	80	108	115	473	HO DVA 307
32	25	10	114	33	58	180	80	116	122	665	HO DVA 308
40	32	10	119	30	72	208	80	134	144	770	HO DVA 309
50	40	10	147	35	79	234	120	154	164	1460	HO DVA 310
63	50	10	172	46	98	272	120	184	195	2340	HO DVA 311

Options:

FPM diaphragm order HO DVB\*\*\*

PTFE diaphragm order HO DVC\*\*\*

Travel stop and stroke limiter options available upon request.

## LR Pressure loading/relief valves EPDM seals

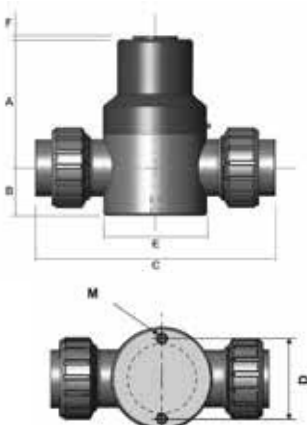

Size	DN	PN	A	B	C	D	E	F	M	gms	Code
16	10	10	85	26	133	40	52	3	M5	101	HO LRA 305
20	15	10	85	26	133	40	52	3	M5	101	HO LRA 306
25	20	10	102	33	153	50	64	3	M5	257	HO LRA 307
32	25	10	105	35	174	60	79	3	M6	425	HO LRA 308
40	30	10	113	42	204	70	89	3	M6	607	HO LRA 309
50	40	10	137	46	233	80	109	6	M6	1005	HO LRA 310
63	50	10	153	57	291	100	126	6	M6	1444	HO LRA 311

\*Max (3 Bar loading) (10 Bar relief)

Options:

FPM options order HO LRB\*\*\*

PTFE options order HO LRC\*\*\*

## FK Butterfly valves Glass reinforced polypropylene with ABS disc

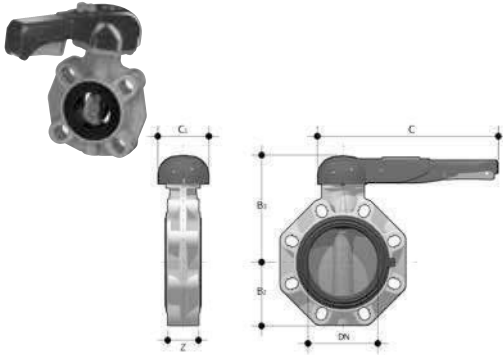

lever operated

d	DN	PN	B <sub>2</sub>	B <sub>3</sub>	C	C <sub>1</sub>	gms	U	Z	Code
50	40	16	60	137	175	100	900	4	33	HO FKA 106
63	50	16	70	143	175	100	1080	4	43	HO FKA 107
75	65	10	80	164	272	110	1470	4	46	HO FKA 108
90	80	10	93	178	272	110	1870	8	49	HO FKA 109
110	100	10	107	192	272	110	2220	8	56	HO FKA 110
140	125	10	120	212	330	110	3100	8	64	HO FKA 111
160	150	10	134	225	330	110	3850	8	70	HO FKA 112
225	200	10	161	272	420	122	6750	8	71	HO FKA 113

Options:

FPM seals order HO FKB\*\*\*

U = No. of holes

with gear box

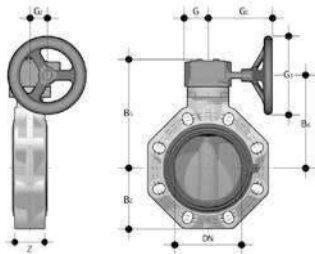

Size	DN	PN	B <sub>2</sub>	B <sub>5</sub>	B <sub>6</sub>	G	G <sub>1</sub>	G <sub>2</sub>	G <sub>3</sub>	gms	U	Z	Code
75	65	10	80	174	146	48	135	39	125	2400	4	46	HV FKA 108
90	80	10	93	188	160	48	135	39	125	2800	8	49	HV FKA 109
110	100	10	107	202	174	48	135	39	125	3150	8	56	HV FKA 110
140	125	10	120	222	194	48	144	39	200	4450	8	64	HV FKA 111
160	150	10	134	235	207	48	144	39	200	5200	8	70	HV FKA 112
225	200	10	161	287	256	65	204	60	200	9300	8	71	HV FKA 113
250	250	10	210	317	281	88	236	76	250	18600	12	114	HV FKA 114
315	300	8	245	374	338	88	236	76	250	25600	12	114	HV FKA 115

Options:

FPM seals order HV FKB\*\*\*

U = No. of holes

**Note:** Lugged versions available to special order. Please refer to our Valve Department for further details.

Our valve range can be electrically or pneumatically actuated.  
For further details see page 77, or contact our Valve Department on 01543 471681.

## Accessories

### Cobra pipe clips

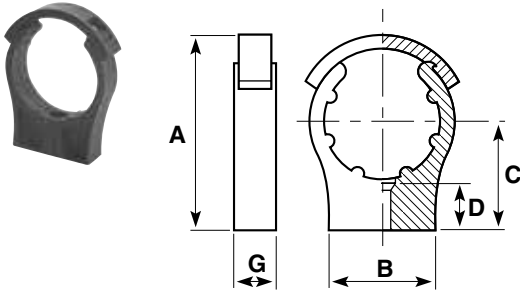

Size	A	B	C	D	G	Bolt/Screw	gms	Code
*12	–	24	25	15	16	M4/3BA/No 8	5	13 434 304
*16	–	35	25	17	16	M4/3BA/No 8	7	13 434 305
*20	–	35	30	14	16	M5/1BA/No 10	8	13 434 306
*25	–	35	35	16	17	M5/1BA/No 10	11	13 434 307
32	65	45	40	17	17	M5/1BA/No 10	14	13 434 308
40	75	45	45	20	20	M5/1BA/No 10	21	13 434 309
50	85	50	50	22	21	M6/0BA/No 10	30	13 434 310
63	102	60	60	19	21	M6/0BA/No 10	42	13 434 311
75	122	70	70	27	31	M8	94	13 434 312
90	148	80	90	39	31	M8	121	13 434 313
110	171	90	96	36	35	M8	184	13 434 314
125	204	144	132	40	40	M8	237	13 434 315
140	211	156	132	40	40	M8	252	13 434 316
160	243	170	150	40	40	M8	330	13 434 317

\*Without retaining clips. Bolts/screws not supplied.

### Rubber lined pipe clips



Size mm	Thread	Code
16	M10	FT PC 1600
20	M10	FT PC 2000
25	M10	FT PC 2500
32	M10	FT PC 3200
40	M10	FT PC 4000
50	M10	FT PC 5000
63	M10	FT PC 6300
75	M10	FT PC 7500
90	M10	FT PC 9000
110	M10	FT PC 1100
160	M10	FT PC 1601

### One-step solvent cement



Litres	gms	Code
0.5	550	03 461 395
1.0	1100	03 461 396

Only Durapipe ABS solvent cement and Durapipe Eco-cleaner should be used for jointing of Durapipe ABS pipework systems.

## Eco-cleaner



Litres	gms	Code
0.5	500	03 457 395

Only Durapipe ABS solvent cement and Durapipe Eco-cleaner should be used for jointing of Durapipe ABS pipework systems.

## Chamfering and de-burring tools



Description	Product code
E 16-63mm pipe inner and outer milling cutter tool	FT 55 65 12
32-160mm chamfering tool	FT 55 05 10

## Pipe cutters



Description	Product code
16-63mm pipe cutter	FT 80 00 01
50-125mm pipe cutter	FT 80 00 03
16-63mm spare cutter wheel	FT 80 00 02
50-125mm spare cutter wheel	FT 80 00 04

## Fibreseal



Description	Product code
Sealing tape for threaded connections	03 469 395

# Index to SuperFLO ABS Imperial Fittings

**Note:** Two-dimensional Auto-CAD drawings are available on [www.durapipe.co.uk](http://www.durapipe.co.uk)

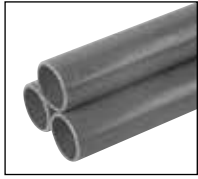

Pipe (plain)  
page 50



Sockets (plain)  
page 51

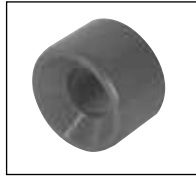

Reducing bushes  
(plain)  
page 51

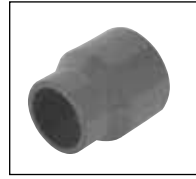

Reducing sockets  
(plain)  
page 52



Elbows 45° (plain)  
page 52



Elbows 90° (plain)  
page 52



Tees 45° (equal plain)  
page 53



Tees 90° (equal plain)  
page 53



Tees 90° (swept plain)  
page 53



Tees 90° (reducing)  
page 53



Bends 22½°  
(long radius)  
page 54



Bends 45°  
(long radius)  
page 54



Bends 90°  
(long radius)  
page 54



Bends 90°  
(short radius plain)  
page 54

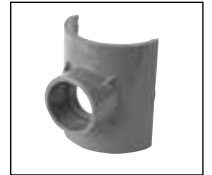

Saddles (plain)  
page 55



End caps (plain)  
page 55

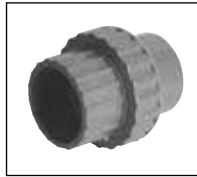

Socket unions (plain)  
page 55



Imperial/metric socket  
adaptors (plain)  
page 56



Sockets  
(plain female BSP thread)  
page 56

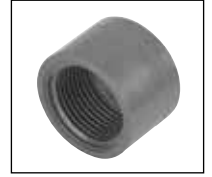

Reducing bushes  
(plain female BSP thread)  
page 56



Elbows 90°  
(plain female BSP thread)  
page 57



Female adaptors  
(plain spigot end/female  
BSP thread) page 57



Hexagon nipples male  
(plain spigot/male BSP  
thread) page 57



Male threaded adaptors  
(plain/male BSP taper  
threaded) page 58



Barrel nipples  
(plain/BSP taper threaded)  
page 58



Hose adaptors  
(BSP taper threaded/  
hose tail) page 58



Tank connectors  
(plain spigot/male BSP  
parallel thread) page 59



Female composite unions  
(plain/brass, BSP parallel  
thread) page 59



Male composite unions  
(plain/brass, BSP taper  
thread) page 59



Female composite unions  
(plain/stainless steel, BSP  
parallel thread) page 60



Male composite unions  
(plain/stainless steel, BSP  
parallel thread) page 60



Sockets  
(female BSP taper  
thread) page 60



Reducing bushes  
(male/female BSP  
thread) page 61



Elbows 90°  
(female BSP taper  
thread) page 61



End caps  
(female BSP taper  
thread) page 61



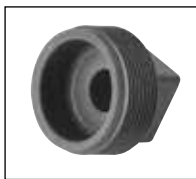

Plugs  
(male BSP taper thread)  
page 62



Hexagon nipples  
(male BSP taper thread)  
page 62

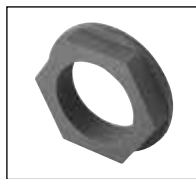

Back nuts  
(female BSP taper thread)  
page 62



Flanges stub  
(plain/serrated)  
page 62



Flanges full face  
(plain/drilled)  
page 63

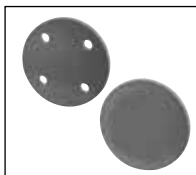

Flanges blanking  
(plain/drilled)  
page 64



Backing rings  
(galvanised mild steel  
drilled) page 65

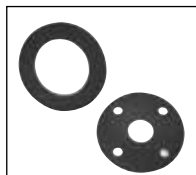

Gaskets flat/full face  
(stub flange EPDM/  
drilled EPDM) page 66



Valve support plates  
(galvanised mild steel)  
page 67

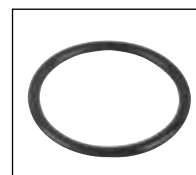

O-Rings  
page 67

## Valves



VKD Double union ball valves (manual - EPDM seals)  
page 68

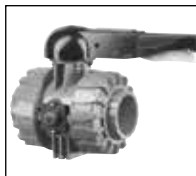

TKD 3-way ball valves  
(manual - EPDM seals)  
page 68



VXE Easyfit double union  
ball valves (manual -  
EPDM seals) page 69



VKR Metering ball valve  
(manual - EPDM seals)  
page 69



SX Easyfit ball check valves  
(EPDM seals)  
page 69



SA Easyfit air release valves  
(EPDM seals)  
page 70



RV Y-Type strainers  
(EPDM seals)  
page 70



Dialock Diaphragm  
valves (manual - EPDM  
seals) page 70



Pressure Loading/Relief  
valves (EPDM seals)  
page 71



FK Butterfly valves (glass  
reinforced polypropylene with  
ABS disc and EPDM seals)  
page 71

## Accessories



ABS One-step solvent cement  
page 72



Eco-cleaner  
page 72



Cobra pipe clips  
(polypropylene) page 72



Saddle clips  
(polypropylene) page 72



Chamfering and  
de-burring tools  
page 73



Pipe cutters  
page 73



Fibreseal tape  
page 73

## SuperFLO ABS Pipe imperial system Plain

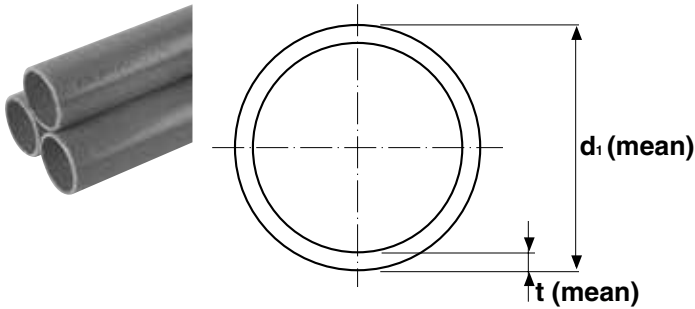

### Pipe - ABS Class C (9 bar)

Size	Mean OD d <sub>1</sub>	Thickness t (mm)	Length (m)	Weight kg/m	Code
1	33.6	2.0	6	0.21	01 511 104
1 <sup>1</sup> / <sub>4</sub>	42.2	2.5	6	0.32	01 511 105
1 <sup>1</sup> / <sub>2</sub>	48.3	2.8	6	0.42	01 511 106
2	60.3	3.6	6	0.67	01 511 107
2 <sup>1</sup> / <sub>2</sub>	75.2	5.0	6	1.14	11 551 312
3	88.9	5.2	6	1.40	01 511 109
4	114.3	6.6	6	2.32	01 511 110
5	140.2	9.3	6	3.97	11 551 316
6	168.3	9.9	6	5.12	01 511 112
8	219.1	12.7	6	8.57	01 511 113

\*Note: 2<sup>1</sup>/<sub>2</sub>" & 5" pipes dimensionally compatible with 75mm and 140mm PN10 Metric series and are manufactured in accordance with the general requirements of DIN 8061/8062.

### Pipe - ABS Class D (12 bar)

Size	Mean OD d <sub>1</sub>	Thickness t (mm)	Length (m)	Weight kg/m	Code
6	168.3	12.8	6	6.50	01 512 112

### Pipe - ABS Class E (15 bar)

Size	Mean OD d <sub>1</sub>	Thickness t (mm)	Length (m)	Weight kg/m	Code
<sup>3</sup> / <sub>8</sub>	17.1	1.7	6	0.09	01 513 101
<sup>1</sup> / <sub>2</sub>	21.4	2.0	6	0.13	01 513 102
<sup>3</sup> / <sub>4</sub>	26.7	2.5	6	0.20	01 513 103
1	33.6	3.1	6	0.31	01 513 104
1 <sup>1</sup> / <sub>4</sub>	42.2	3.9	6	0.49	01 513 105
1 <sup>1</sup> / <sub>2</sub>	48.3	4.5	6	0.64	01 513 106
2	60.3	5.6	6	1.00	01 513 107
3	88.9	8.3	6	2.16	01 513 109
4	114.3	10.6	6	3.59	01 513 110

### Pipe - ABS Class T (for threading)

(12 bar after threading)

Size	Mean OD d <sub>1</sub>	Thickness t (mm)	Length (m)	Weight kg/m	Code
<sup>3</sup> / <sub>8</sub>	17.1	3.5	6	0.16	01 514 101
<sup>1</sup> / <sub>2</sub>	21.4	3.6	6	0.22	01 514 102
<sup>3</sup> / <sub>4</sub>	26.7	3.6	6	0.28	01 514 103
1	33.6	4.3	6	0.43	01 514 104
1 <sup>1</sup> / <sub>4</sub>	42.2	5.3	6	0.65	01 514 105
1 <sup>1</sup> / <sub>2</sub>	48.3	6.0	6	0.85	01 514 106
2	60.3	7.2	6	1.28	01 514 107

## Sockets Plain

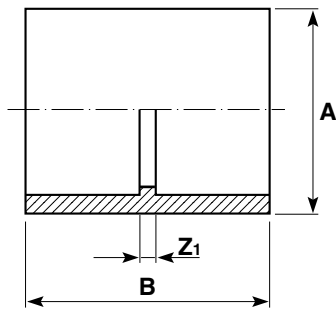

Size	PN	A	B	Z <sub>1</sub>	gms	Code
3/8	15	21	32	2	4	01 100 101
1/2	15	26	38	2	6	01 100 102
3/4	15	32	43	3	12	01 100 103
1	15	41	50	3	24	01 100 104
1 1/4	15	52	60	4	41	01 100 105
1 1/2	15	60	66	2	62	01 100 106
2	15	74	78	4	114	01 100 107
2 1/2	9	88	94	4	230	11 100 312
3	15	108	104	4	355	01 100 109
4	15	136	135	5	595	01 100 110
5	9	171	163	7	1390	11 100 316
6	12	201	191	9	2269	01 100 112
8	9	257	249	11	3668	01 100 113

## Reducing bushes Plain

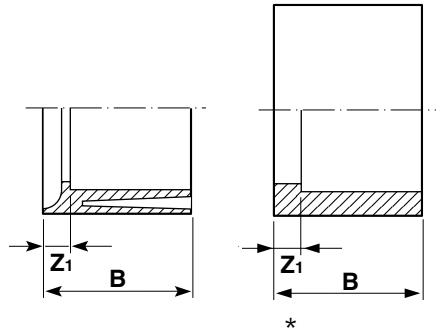
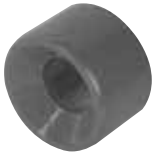

Size	PN	B	Z <sub>1</sub>	gms	Code
1/2 x 3/8	15	17	2	7	01 109 121
3/4 x 1/2	15	20	3	8	01 109 122
1 x 1/2	15	23	6	23	01 109 123
1 x 3/4	15	24	4	15	01 109 124
*1 1/4 x 1/2	15	28	12	21	01 109 116
*1 1/4 x 3/4	15	28	8	24	01 109 117
1 1/4 x 1	15	28	5	20	01 109 125
*1 1/2 x 1/2	15	30	13	26	01 109 118
*1 1/2 x 3/4	15	30	10	37	01 109 119
*1 1/2 x 1	15	30	7	40	01 109 126
1 1/2 x 1 1/4	15	31	4	19	01 109 127
*2 x 3/4	15	38	15	45	01 109 120
*2 x 1	15	38	15	45	01 109 128
*2 x 1 1/4	15	38	11	57	01 109 129
2 x 1 1/2	15	37	7	42	01 109 130
2 1/2 x 2	15	44	8	75	01 109 131
*3 x 1 1/2	15	51	21	130	01 109 134
*3 x 2	15	51	15	178	01 109 135
3 x 2 1/2	15	50	6	126	01 109 136
*4 x 3	15	65	12	277	01 109 141
5 x 4	15	78	15	413	01 329 142
*6 x 4	12	93	27	666	01 109 147
6 x 5	15	90	13	641	01 329 148
*8 x 6	9	110	23	1185	01 109 152

\*Relief configuration (see drawing insert).

## Reducing sockets Plain

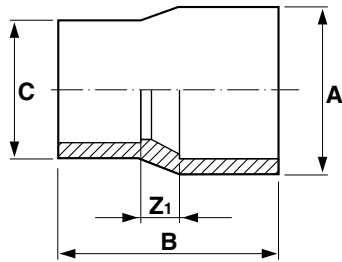

Size	PN	A	B	C	Z <sub>1</sub>	gms	Code
3/4 x 1/2	15	32	44	26	7	11	01 114 122
1 x 3/4	15	41	53	33	9	19	01 114 124
1 1/4 x 1	15	52	63	41	10	39	01 114 125
1 1/2 x 1 1/4	15	59	68	51	8	58	01 114 127
2 x 1 1/2	15	74	82	59	12	100	01 114 130
3 x 2	15	108	114	75	26	320	01 114 135
4 x 3	15	136	136	108	20	558	01 114 141
6 x 4	12	205	213	140	55	1975	01 114 147
8 x 6	9	256	263	198	50	3410	01 114 152

## Elbows 45° Plain

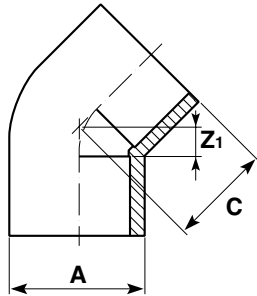

Size	PN	A	C	Z <sub>1</sub>	gms	Code
3/8	15	21	20	6	8	01 119 101
1/2	15	27	26	8	9	01 119 102
3/4	15	33	27	12	15	01 119 103
1	15	41	37	13	25	01 119 104
1 1/4	15	52	44	15	59	01 119 105
1 1/2	15	60	50	18	86	01 119 106
2	15	82	66	27	160	01 119 107
2 1/2	10	90	63	17	300	11 119 312
3	15	112	94	40	750	01 119 109
4	15	139	115	50	1300	01 119 110
5	10	173	115	37	1980	11 119 316
6	12	198	134	41	2390	01 119 112
8	9	259	182	65	5620	01 119 113

## Elbows 90° Plain

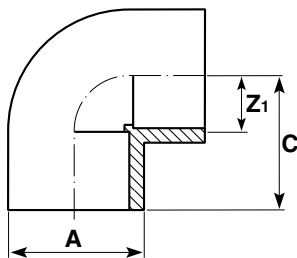

Size	PN	A	C	Z <sub>1</sub>	gms	Code
3/8	15	21	24	9	6	01 115 101
1/2	15	26	29	12	11	01 115 102
3/4	15	32	34	14	19	01 115 103
1	15	41	41	17	35	01 115 104
1 1/4	15	52	49	21	70	01 115 105
1 1/2	15	60	56	26	101	01 115 106
2	15	74	68	31	191	01 115 107
2 1/2	10	90	83	38	385	11 115 312
3	15	111	104	52	720	01 115 109
4	15	141	130	65	1505	01 115 110
5	10	173	153	76	2390	11 115 316
6	12	203	175	85	4075	01 115 112
8	9	256	251	112	6900	01 115 113

## Tees 45° Plain

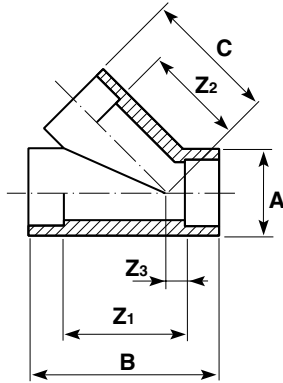

Size	PN	A	B	C	Z <sub>1</sub>	Z <sub>2</sub>	Z <sub>3</sub>	gms	Code
1/2	9	28	68	44	34	27	7	30	01 128 102
3/4	9	33	81	52	41	32	8	45	01 128 103
1	9	41	97	63	49	39	9	80	01 128 104
1 1/4	9	50	117	80	61	52	10	194	01 128 105
1 1/2	9	60	140	97	80	67	12	298	01 128 106
2	9	74	170	113	90	73	15	546	01 128 107

## Tees 90° Equal plain

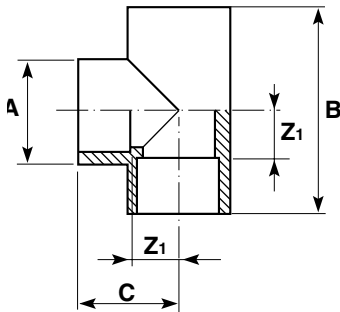

Size	PN	A	B	C	Z <sub>1</sub>	gms	Code
3/8	15	21	49	25	10	7	01 122 101
1/2	15	26	58	29	11	13	01 122 102
3/4	15	32	69	34	15	23	01 122 103
1	15	41	83	42	19	43	01 122 104
1 1/4	15	52	101	50	23	92	01 122 105
1 1/2	15	59	113	53	25	133	01 122 106
2	15	74	137	70	31	249	01 122 107
2 1/2	10	90	172	87	36	510	11 122 312
3	15	113	204	105	44	926	01 122 109
4	15	143	244	121	54	1960	01 122 110
5	10	172	307	153	72	3200	11 122 316
6	12	205	355	175	88	4449	01 122 112
8	9	257	468	240	100	9600	01 122 113

## Tees 90° Swept plain

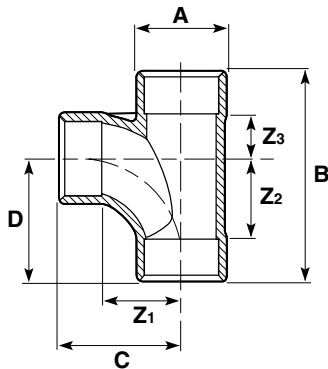

Size	PN	A	B	C	D	Z <sub>1</sub>	Z <sub>2</sub>	Z <sub>3</sub>	gms	Code
1	9	41	115	79	79	57	57	14	85	01 148 104
1 1/2	9	62	160	105	105	74	74	24	285	01 148 106
2	9	78	195	125	125	87	87	32	515	01 148 107
2 1/2	9	92	210	125	125	81	81	41	601	01 148 108
4	9	139	315	190	190	127	127	62	2080	01 148 110

## Tees 90° Reducing

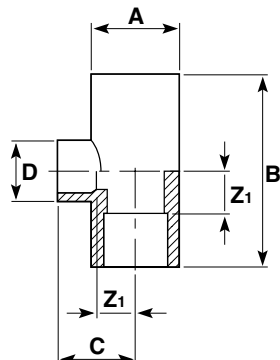

Size	PN	A	B	C	D	Z <sub>1</sub>	gms	Code
3/4 x 1/2	15	32	64	32	26	17	22	01 124 122
1 x 1/2	15	40	70	36	26	17	40	01 124 123
1 x 3/4	15	40	76	38	32	20	41	01 124 124

## Bends 22½° Long radius

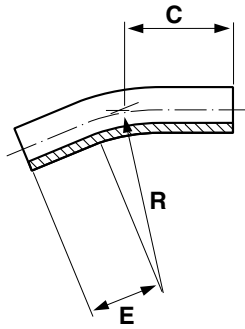

Size	PN	C	E	R	gms	Code
1	15	76	38	102	46	01 311 104
1½	15	110	57	152	143	01 311 106
2	15	113	73	203	274	01 311 107
2½	10	172	112	300	319	11 311 312
3	15	202	114	305	857	01 311 109
4	15	262	152	407	1886	01 311 110
5	10	322	210	560	2513	11 311 316
6	12	385	229	610	5154	01 311 112
8	9	503	305	812	8962	01 311 113

Tolerance on angle 3

## Bends 45° Long radius

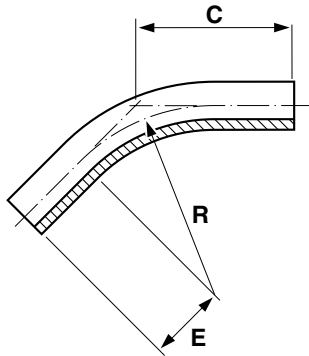

Size	PN	C	E	R	gms	Code
1	15	75	37	102	51	01 310 104
1½	15	113	55	152	156	01 310 106
2	15	152	73	203	322	01 310 107
2½	10	300	113	300	429	11 310 312
3	15	238	121	305	1100	01 310 109
4	15	300	145	407	2290	01 310 110
5	10	512	280	560	5315	11 310 316
6	12	440	218	610	6290	01 310 112
8	9	592	280	812	11440	01 310 113

Tolerance on angle 3

## Bends 90° Long radius

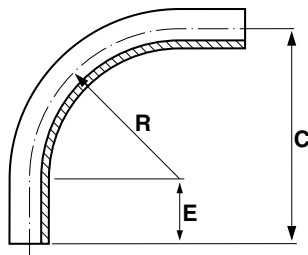

Size	PN	C	E	R	gms	Code
3	15	403	98	305	1535	01 309 109
4	15	545	138	407	3440	01 309 110
5	10	840	280	560	6696	11 309 316
6	12	817	207	610	9430	01 309 112
8	9	1174	362	812	19070	01 309 113

Tolerance on angle 3

## Bends 90° Short radius plain

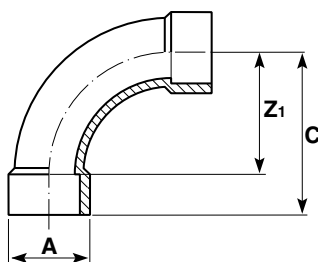

Size	PN	A	C	Z <sub>1</sub>	gms	Code
½	15	26	56	43	20	01 118 102
¾	15	33	65	45	45	01 118 103
1	15	40	85	63	65	01 118 104
1¼	15	51	108	81	130	01 118 105
1½	15	62	134	102	290	01 118 106
2	15	73	165	126	560	01 118 107
2½	10	93	195	150	810	11 118 312
3	15	111	226	172	1445	01 118 109
4	15	140	280	216	2400	01 118 110

## Saddles Plain

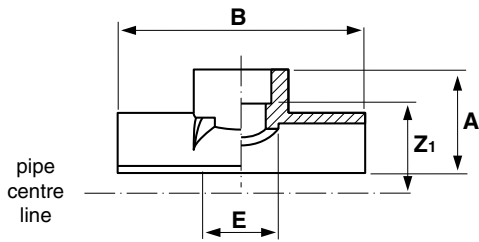

Size	PN	A	B	E	Z <sub>1</sub>	gms	Code
2 x 1 <sup>1</sup> / <sub>4</sub>	15	60	136	48	33	90	01 126 129
3 x 1 <sup>1</sup> / <sub>2</sub>	15	76	140	60	46	158	01 126 134
4 x 2	15	95	140	74	58	230	01 126 140
6 x 2	15	71	154	73	86	225	01 126 146

Two saddles can be mounted diametrically opposite.

## End caps Plain

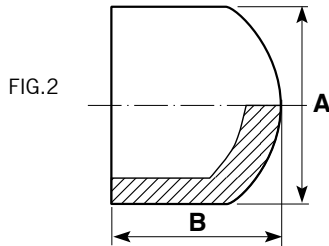
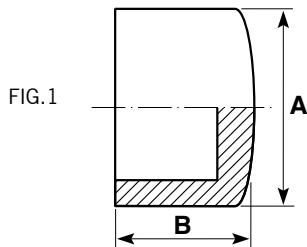

Size	PN	A	B	gms	Fig	Code
<sup>3</sup> / <sub>8</sub>	15	21	17	3	1	01 140 101
<sup>1</sup> / <sub>2</sub>	15	26	22	5	1	01 140 102
<sup>3</sup> / <sub>4</sub>	15	32	25	9	1	01 140 103
1	15	40	30	20	1	01 140 104
1 <sup>1</sup> / <sub>4</sub>	15	52	51	33	2	01 140 105
1 <sup>1</sup> / <sub>2</sub>	15	59	39	48	1	01 140 106
2	15	74	70	90	2	01 140 107
*2 <sup>1</sup> / <sub>2</sub>	10	94	59	180	1	11 149 312
3	15	109	97	268	2	01 140 109
4	15	136	120	465	2	01 140 110

\*2<sup>1</sup>/<sub>2</sub> is rated at PN10.

## Socket unions Plain

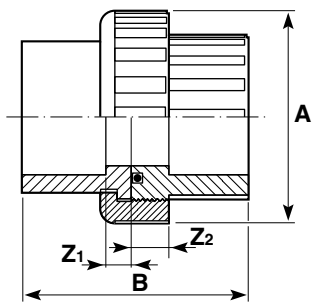

Size	PN	A	B	Z <sub>1</sub>	Z <sub>2</sub>	gms	Code
<sup>3</sup> / <sub>8</sub>	15	39	44	5	10	25	01 205 101
<sup>1</sup> / <sub>2</sub>	15	43	49	5	10	36	01 205 102
<sup>3</sup> / <sub>4</sub>	15	51	55	5	10	51	01 205 103
1	15	64	65	7	12	86	01 205 104
1 <sup>1</sup> / <sub>4</sub>	15	72	77	10	14	122	01 205 105
1 <sup>1</sup> / <sub>2</sub>	15	79	92	13	16	160	01 205 106
2	15	102	112	15	19	297	01 205 107
*2 <sup>1</sup> / <sub>2</sub>	10	135	107	8	13	610	11 205 312
3	9	155	113	6	4	750	01 205 109
4	9	180	138	7	6	1155	01 205 110

EPDM seal as standard.

For FPM seal order 01 204 1\*\*

## Imperial/metric socket adaptors Plain

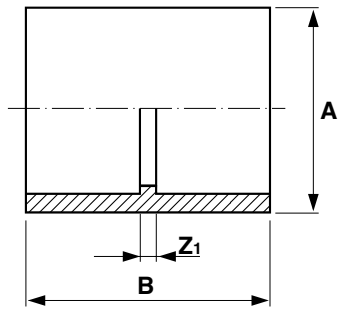

Size	PN	A	B	Z <sub>1</sub>	gms	Code
1/2 x 20	10	26	37	3	7	11 345 102
3/4 x 25	10	31	41	3	12	11 345 103
1 x 32	10	40	49	3	25	11 345 104
1 1/4 x 40	10	50	58	2	45	11 345 105
1 1/2 x 50	10	59	67	3	62	11 345 106
2 x 63	10	74	78	2	114	11 345 107
3 x 90	10	107	105	3	355	11 345 109
4 x 110	10	134	130	6	690	11 345 110
6 x 160	10	195	183	8	1660	11 345 112

## Sockets Plain female BSP thread

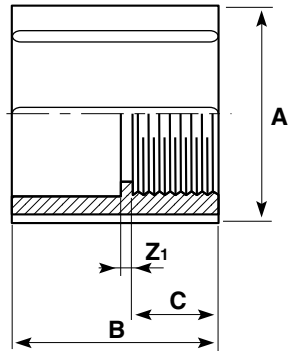

Size	PN	A	B	C	Z <sub>1</sub>	gms	Code
1/2	12	27	38	17	4	8	01 101 102
3/4	12	33	44	20	2	14	01 101 103
1	12	42	51	23	5	30	01 101 104
1 1/4	12	52	55	22	4	46	01 101 105
1 1/2	12	60	61	26	2	65	01 101 106
2	12	75	70	29	2	114	01 101 107
3	12	110	107	52	3	378	01 101 109

## Reducing bushes Plain female BSP thread

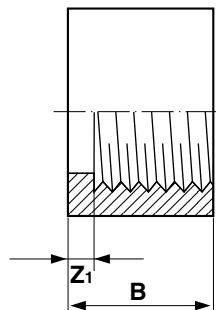

Size	PN	B	Z <sub>1</sub>	gms	Code
1/2 x 3/8	12	17	6	4	01 111 121
3/8 x 1/2	12	20	5	7	01 111 122
1 x 3/4	12	23	6	12	01 111 124



## Elbows 90° Plain female BSP thread

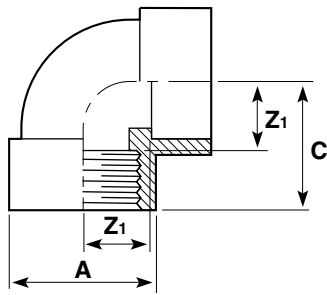

Size	PN	A	C	Z <sub>1</sub>	gms	Code
1/2	12	26	34	17	26	01 116 102
3/4	12	32	36	20	34	01 116 103
1	12	40	41	23	63	01 116 104
1 1/2	12	62	57	30	136	01 116 106
2	12	75	66	35	203	01 116 107

## Female threaded adaptors Plain spigot end/female BSP thread

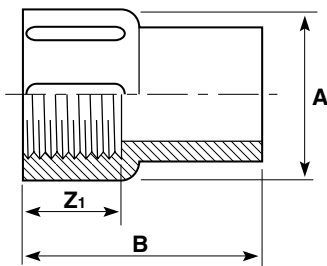

Size	PN	A	B	Z <sub>1</sub>	gms	Code
1/2	12	27	38	16	8	01 153 102
3/4	12	36	44	18	14	01 153 103
1	12	43	50	21	24	01 153 104
1 1/4	12	55	60	22	49	01 153 105
1 1/2	12	63	66	25	68	01 153 106
2	12	78	78	29	129	01 153 107

## Hexagon nipples Plain spigot/male BSP thread

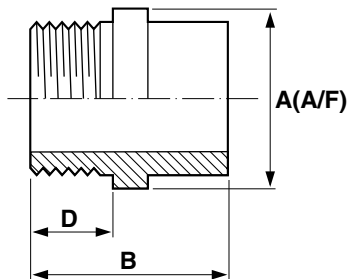

Size	PN	A	B	D	gms	Code
3/8	12	24	36	11	7	01 107 101
1/2	12	30	42	15	12	01 107 102
3/4	12	36	48	16	30	01 107 103
1	12	46	56	20	40	01 107 104
1 1/4	12	46	60	21	50	01 107 105
1 1/2	12	55	63	22	58	01 107 106
2	12	72	74	26	91	01 107 107

## Male threaded adaptors Plain/male BSP taper threaded

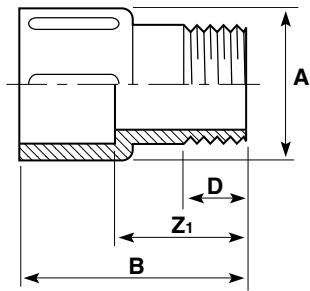

Size	PN	A	B	D	Z <sub>1</sub>	gms	Code
3/8	12	22	35	10	20	5	01 151 101
1/2	12	27	45	12	28	9	01 151 102
3/4	12	35	48	14	28	14	01 151 103

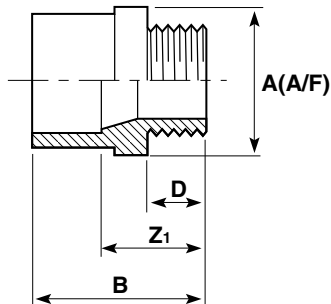

Size	PN	A	B	D	Z <sub>1</sub>	gms	Code
1	12	46	58	19	35	36	01 151 104
1 1/4	12	56	66	22	38	70	01 151 105
1 1/2	12	72	75	22	43	115	01 151 106
2	12	80	85	26	46	150	01 151 107

## Barrel nipples Plain/BSP taper threaded

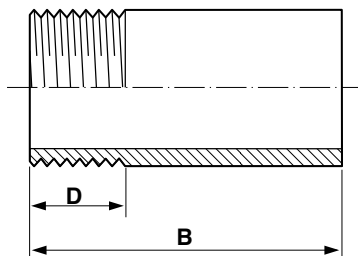

Size	PN	B	D	gms	Code
1/2	12	49	16	10	01 316 102
3/4	12	55	18	15	01 316 103
1	12	62	21	25	01 316 104
1 1/4	12	72	23	45	01 316 105
1 1/2	12	87	30	70	01 316 106
2	12	87	30	115	01 316 107
3	12	128	30	252	01 316 109
4	12	153	36	525	01 316 110

## Hose adaptors BSP taper threaded/hose tail

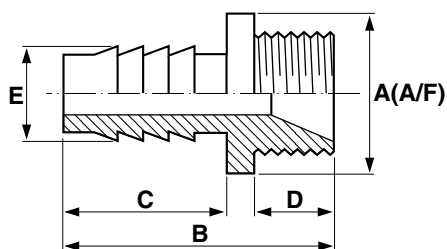

Size	PN	A	B	C	D	E	gms	Code
1/2	12	26	60	41	13	14	8	01 157 102
3/4	12	28	66	41	16	20	15	01 157 103
1	12	40	73	46	19	27	28	01 157 104

## Tank connectors Plain spigot/male BSP parallel thread

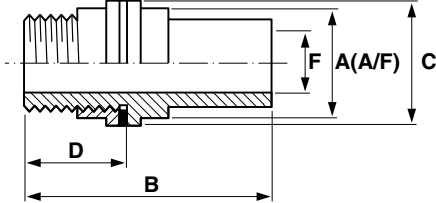

Size	A	B	C	D	F	gms	Code
1/2"	28	70	38	28	15	26	01 235 102
3/4"	33	77	38	38	21	30	01 235 103
1"	45	101	46	55	25	80	01 235 104
1 1/4"	50	120	50	70	32	120	01 235 105
1 1/2"	60	127	60	73	37	170	01 235 106
2"	79	152	79	85	46	325	01 235 107

## Composite unions Plain/brass, female BSP parallel thread

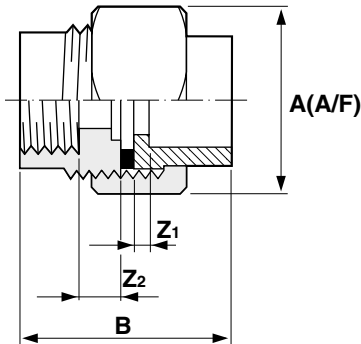

Size	PN	A	B	Z <sub>1</sub>	Z <sub>2</sub>	gms	Code
1/2	15	40	42	3	7	165	01 212 102
3/4	15	48	49	3	9	290	01 212 103
1	15	55	59	11	12	310	01 212 104
1 1/4	15	65	68	9	10	450	01 212 105
1 1/2	15	79	75	12	14	800	01 212 106
2	15	88	90	14	14	950	01 212 107

Fitted with brass retaining nut.

Brass material to BS2872, WRAS approved.

**ALL** Durapipe Brass Components are manufactured using DZR Brass.

## Composite unions Plain/brass, male BSP taper thread

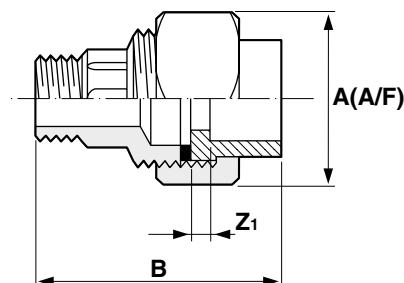

Size	PN	A	B	Z <sub>1</sub>	gms	Code
1/2	15	40	54	3	175	01 217 102
3/4	15	48	74	3	320	01 217 103
1	15	55	86	8	420	01 217 104
1 1/4	15	65	94	10	620	01 217 105
1 1/2	15	78	108	13	1000	01 217 106
2	15	88	129	15	1200	01 217 107

Fitted with brass retaining nut.

Brass material to BS2872, WRAS approved.

**ALL** Durapipe Brass Components are manufactured using DZR Brass.

## Composite unions Plain/stainless steel, female BSP parallel thread

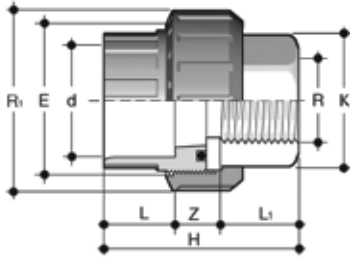

Size	PN	E	H	K	Z	gms	Code
1/2*	15	41	48.5	25	16	81	01 219 102
3/4*	15	50	54.5	32	17	152	01 219 103
1*	15	58	59.5	38	18	170	01 219 104
1 1/4*	15	72	68.5	48	21	353	01 219 105
1 1/2*	15	79	84.5	55	30.5	435	01 219 106
2*	15	98	94.5	69	29.5	779	01 219 107

\*Thread sizes designation.

**ALL** Durapipe Stainless Steel Components are manufactured using 316L Grade Stainless Steel.

## Composite unions Plain/stainless steel, male BSP parallel thread

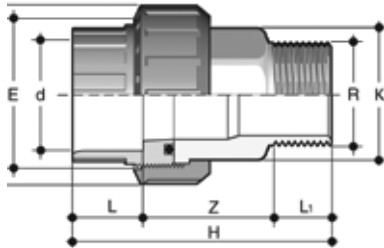

Size	PN	E	H	K	Z	gms	Code
1/2*	15	41	65	25	35.5	123	01 218 102
3/4*	15	50	72.5	32	38.5	215	01 218 103
1*	15	58	80	38	40.5	269	01 218 104
1 1/4*	15	72	91	48	45.5	516	01 218 105
1 1/2*	15	79	101	55	50.5	639	01 218 106
2*	15	98	122.5	69	60.5	1111	01 218 107

\*Thread sizes designation.

**ALL** Durapipe Stainless Steel Components are manufactured using 316L Grade Stainless Steel.

## Sockets Female BSP taper thread

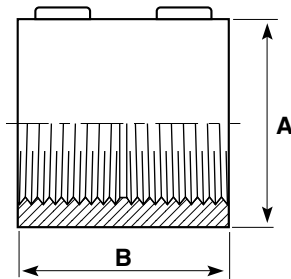

Size	PN	A	B	gms	Code
1/2	12	26	38	12	01 102 102
3/4	12	33	43	22	01 102 103
1	12	41	51	34	01 102 104
1 1/4	12	51	54	60	01 102 105
1 1/2	12	62	63	87	01 102 106
2	12	75	72	132	01 102 107
3	12	110	107	437	01 102 109

## Reducing bushes Male/female BSP thread

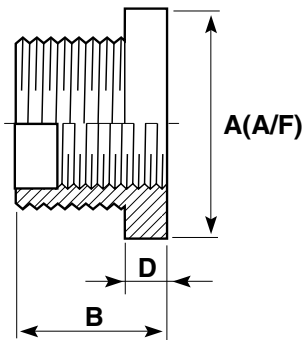

Size	PN	A	B	D	gms	Code
1/2 x 3/8	12	24	25	10	5	01 113 121
3/4 x 1/2	12	30	27	11	10	01 113 122
1 x 3/4	12	36	31	12	13	01 113 124

Male thread taper.  
Female thread parallel.

## Elbows 90° Female BSP taper thread

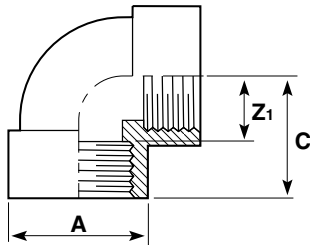

Size	PN	A	C	Z <sub>1</sub>	gms	Code
1/2	12	26	29	17	27	01 117 102
3/4	12	32	33	19	39	01 117 103
1	12	41	41	23	65	01 117 104
1 1/2	12	63	57	30	141	01 117 106
2	12	75	67	35	212	01 117 107

## End caps Female BSP taper thread

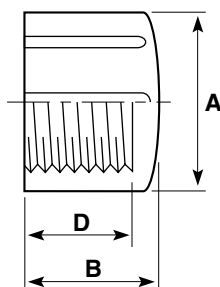

Size	PN	A	B	D	gms	Code
3/8	12	26	20	16	5	01 141 101
1/2	12	27	20	16	6	01 141 102
3/4	12	36	23	17	10	01 141 103
1	12	44	28	21	18	01 141 104
1 1/4	12	55	31	22	33	01 141 105
1 1/2	12	63	35	25	50	01 141 106
2	12	78	40	28	90	01 141 107
3	12	111	65	53	262	01 141 109

## Plugs Male BSP taper thread

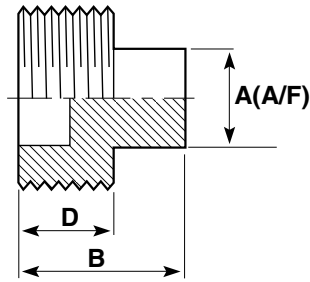

Size	PN	A	B	D	gms	Code
3/8	12	11	19	10	3	01 155 101
1/2	12	13	23	14	5	01 155 102
3/4	12	14	28	15	8	01 155 103
1	12	17	30	17	12	01 155 104
1 1/4	12	22	35	22	30	01 155 105
1 1/2	12	27	38	22	36	01 155 106
2	12	37	45	26	50	01 155 107

## Hexagon nipples Male BSP taper thread

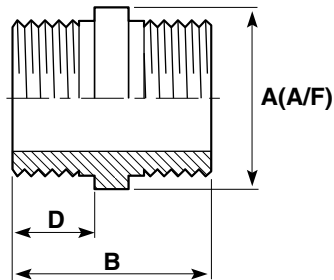

Size	PN	A	B	D	gms	Code
3/8	12	24	38	14	6	01 106 101
1/2	12	30	46	18	12	01 106 102
3/4	12	36	50	19	30	01 106 103
1	12	46	59	13	40	01 106 104
1 1/4	12	46	67	27	55	01 106 105
1 1/2	12	55	73	29	75	01 106 106
2	12	72	81	33	125	01 106 107

## Back nuts Female BSP taper thread

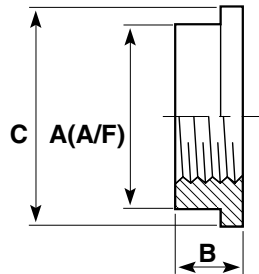

Size	PN	A	B	C	gms	Code
3/8	12	25	11	29	5	01 159 101
1/2	12	28	13	38	8	01 159 102
3/4	12	33	13	38	15	01 159 103
1	12	45	16	54	18	01 159 104
1 1/4	12	50	18	58	19	01 159 105
1 1/2	12	60	19	69	31	01 159 106
2	12	79	21	91	65	01 159 107

## Flanges stub Plain/serrated

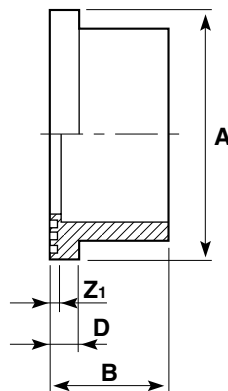

Size	PN	A	B	D	Z <sub>1</sub>	gms	Code
2	15	96	40	14	3	90	01 135 107
2 1/2	10	106	49	10	4	150	11 135 312
3	15	127	57	18	6	200	01 135 109
4	15	159	69	20	6	350	01 135 110
5	15	180	83	14	7	680	11 135 316
6	12	213	104	24	11	805	01 135 112
8	9	269	132	26	14	2075	01 135 113

All Durapipe flanges are designed for use with Durapipe backing rings. Guarantees are null and void if used with incorrect backing ring.

## Flanges full face Plain/drilled

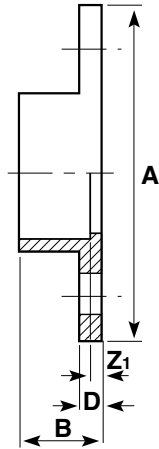

### BS10 Table D/E

Size	A	B	D	Z <sub>1</sub>	P.C.D.	No. of Holes	Hole Diameter	gms	Code
1/2	96	21	10	4	67	4	14	68	01 130 102
3/4	105	24	10	4	73	4	14	78	01 130 103
1	115	27	10	4	83	4	14	107	01 130 104
1 1/4	140	33	10	5	87	4	14	122	01 130 105
1 1/2	150	37	10	5	98	4	14	154	01 130 106
2	166	45	10	6	115	4	18	223	01 130 107
3	199	60	11	8	145	4	18	398	01 130 109
*4	220	72	14	6	178	8	18	638	01 130 110
6	284	98	22	8	235	8	22	1340	01 130 112

\*4† BS10 Table D has 4 holes and should be ordered as 01 317 110.

### BS4504 Table 16/3-10/3

Size	A	B	D	Z <sub>1</sub>	P.C.D.	No. of Holes	Hole Diameter	gms	Code
1/2	96	21	10	4	65	4	14	68	01 319 102
3/4	105	24	10	4	75	4	14	78	01 319 103
1	115	27	10	4	85	4	14	107	01 319 104
1 1/4	140	33	10	5	100	4	18	122	01 319 105
1 1/2	150	37	10	5	110	4	18	154	01 319 106
2	166	45	10	6	125	4	18	223	01 319 107
3	199	60	11	8	160	8	18	398	01 319 109
4	220	72	14	6	180	8	18	638	01 319 110
6	284	98	22	8	240	8	22	1340	01 319 112

### ANSI Class 150

Size	A	B	D	Z <sub>1</sub>	P.C.D.	No. of Holes	Hole Diameter	gms	Code
1/2	96	21	10	4	60	4	14	68	01 322 102
3/4	105	24	10	4	70	4	14	78	01 322 103
1	115	27	10	4	80	4	14	107	01 322 104
1 1/2	150	37	10	5	98	4	14	154	01 130 106
2	166	45	10	6	121	4	18	223	01 322 107
3	199	60	11	8	152	4	18	398	01 322 109
4	220	72	14	6	190	8	18	638	01 322 110
6	284	98	22	8	241	8	22	1340	01 322 112

### Undrilled

Size	PN	A	B	D	Z <sub>1</sub>	gms	Code
1/2	15	96	21	10	4	75	01 129 102
3/4	15	105	24	10	4	85	01 129 103
1	15	115	27	10	4	111	01 129 104
1 1/4	15	140	32	10	4	130	01 129 105
1 1/2	15	150	36	10	5	160	01 129 106
2	15	165	45	11	6	233	01 129 107
3	15	199	60	11	8	414	01 129 109
4	15	220	73	14	6	657	01 129 110
6	12	284	99	22	8	1417	01 129 112

**Note:** Durapipe backing rings must be used in conjunction with full face flanges.

All Durapipe flanges are designed for use with Durapipe backing rings. Guarantees are null and void if used with incorrect backing ring.

## Flanges blanking Plain/drilled

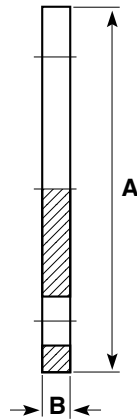

### BS10 Table D/E

Size	A	B	P.C.D.	No. of Holes	Hole Diameter	gms	Code
2	165	13	115	4	18	235	01 313 107
3	197	19	145	4	18	520	01 313 109
*4	214	19	178	8	18	720	01 313 110
6	286	26	235	8	22	1575	01 313 112
8	337	26	292	8	22	2300	01 313 113

\*4† BS10 Table D has 4 holes and should be ordered as 01 326 110.

### BS4504 Table 16/3 (1/2" to 8") 10/3 (1/2" to 6")

Size	A	B	P.C.D.	No. of Holes	Hole Diameter	gms	Code
2	165	13	125	4	18	235	01 323 107
2 <sup>1/2</sup>	186	19	145	4	18	568	11 323 312
3	197	19	160	8	18	520	01 323 109
4	214	19	180	8	18	720	01 323 110
5	251	26	210	8	18	1338	11 323 316
6	286	26	240	8	22	1575	01 323 112
8	337	26	295	12	22	2300	01 323 113

### ANSI Class 150

Size	A	B	P.C.D.	No. of Holes	Hole Diameter	gms	Code
2	165	13	121	4	18	235	01 325 107
3	197	19	152	4	18	520	01 325 109
4	214	19	190	8	18	720	01 325 110
6	286	26	241	8	22	1575	01 325 112
8	337	26	298	8	22	2300	01 325 113

### Undrilled

Size	PN	A	B	gms	Code
1	15	116	13	140	01 131 104
1 <sup>1/2</sup>	15	150	13	185	01 131 106
2	15	166	13	235	01 131 107
3	15	197	19	520	01 131 109
4	15	214	19	720	01 131 110
6	12	286	26	1575	01 131 112
8	9	337	26	2300	01 131 113

**Note:** Durapipe backing rings must be used in conjunction with blank flanges.

**DURAPIPE UK MANUFACTURE FULLY MATCHED PIPEWORK SYSTEMS.  
AS A RESULT WE DO NOT RECOMMEND THE USE OF NON-DURAPIPE PRODUCTS  
INCLUDING BACKING RINGS, GASKETS, SOLVENT CEMENT AND CLEANER.**

**INSIST ON DURAPIPE.**

All Durapipe flanges are designed for use with Durapipe backing rings. Guarantees are null and void if used with incorrect backing ring.



## Backing rings Galvanised mild steel drilled

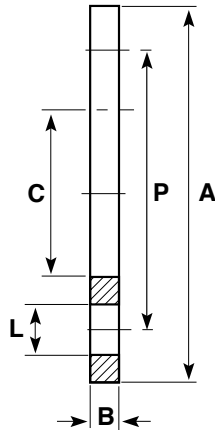

### BS10 Table D/E

Size	A	B	C	P	No. of Holes	Hole Dia.	Bolt Size	Weight gms	Code
1/2	95	6	35	67	4	14	M12x50	270	03 416 102
3/4	103	7	45	73	4	14	M12x50	300	03 416 103
1	114	6	49	83	4	14	M12x50	380	03 416 104
1 1/4	120	7	60	87	4	14	M12x50	380	03 416 105
1 1/2	135	7	68	98	4	14	M12x50	480	03 416 106
2	151	8	78	115	4	18	M16x65	880	03 416 107
3	187	9	110	145	4	18	M16x70	1040	03 416 109
*4	216	9	140	178	8	18	M16x80	1330	03 416 110
6	282	11	195	235	8	22	M20x90	2340	03 416 112
8	337	10	255	292	8	22	M20x100	2870	03 416 113

\*4† BS10 Table D has 4 holes and should be ordered as 03 415 110.

### BS4504 Table 16/3 (1/2" to 12") 10/3 (1/2" to 6")

Size	A	B	C	P	No. of Holes	Hole Dia.	Bolt Size	Weight gms	Code
1/2	95	6	35	65	4	14	M12x50	310	03 421 102
3/4	106	6	45	75	4	14	M12x50	330	03 421 103
1	114	6	49	85	4	14	M12x50	390	03 421 104
1 1/4	141	6	60	100	4	18	M16x50	580	03 421 105
1 1/2	150	6	68	110	4	18	M16x50	880	03 421 106
2	165	8	78	125	4	18	M16x65	1020	03 421 107
2 1/2	186	9	92	145	4	18	M16x65	1280	13 421 312
3	200	8	110	160	8	18	M16x70	1310	03 421 109
4	221	8	140	180	8	18	M16x80	1370	03 421 110
5	251	11	167	210	8	18	M16x90	2060	13 421 316
6	286	11	195	240	8	22	M20x90	2460	03 421 112
8	339	11	255	295	12	22	M20x100	2780	03 421 113

### BS4504 Table 10/3 (8")

Size	A	B	C	P	No. of Holes	Hole Dia.	Bolt Size	Weight gms	Code
8	339	11	255	295	8	22	M20x100	2870	03 404 113

**Note:** The 8" backing ring drilled 10/3 is intended for use in conjunction with the 8" FK Butterfly valve, as the PN10 drilling has 8 holes as apposed to the 12 holes on the PN16 drilling.

### ANSI Class 150

Size	A	B	C	P	No. of Holes	Hole Dia.	Bolt Size	Weight gms	Code
1/2	89	6	35	60	4	14	M12x50	240	03 425 102
3/4	98	6	45	70	4	14	M12x50	270	03 425 103
1	108	6	49	80	4	14	M12x50	330	03 425 104
1 1/2	128	6	68	98	4	14	M12x50	420	03 425 106
2	153	8	78	121	4	18	M16x65	790	03 425 107
3	191	8	110	152	4	18	M16x65	1200	03 425 109
4	230	9	140	190	8	18	M16x70	1580	03 425 110
6	280	11	195	241	8	22	M20x90	2230	03 425 112
8	340	12	255	298	8	22	M20x100	3060	03 425 113

\*Bolt lengths shown are for flange/flange assemblies only.

## Gaskets flat Stub flange EPDM

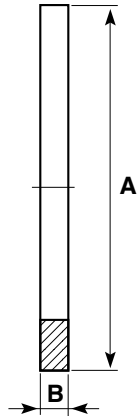

Size	A	B	gms	Code
2	97	3.0	21	03 431 107
2 <sup>1</sup> / <sub>2</sub>	106	3.0	22	13 411 312
3	128	3.0	23	03 431 109
4	160	3.9	36	03 431 110
5	180	4.0	60	13 411 316
6	214	3.9	74	03 431 112
8	269	4.0	92	03 431 113

## Gaskets full face Drilled EPDM

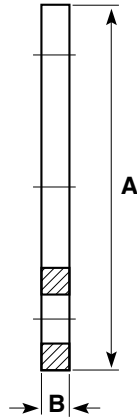

### BS10 Table D/E

Size	A	B	P.C.D.	No. of Holes	Hole Diameter	gms	Code
1/2	95	3.0	67	4	14	31	03 410 102
3/4	112	3.0	73	4	14	37	03 410 103
1	115	3.0	83	4	14	37	03 410 104
1 <sup>1</sup> / <sub>4</sub>	121	3.0	87	4	14	41	03 410 105
1 <sup>1</sup> / <sub>2</sub>	133	3.0	98	4	14	55	03 410 106
2	153	3.0	115	4	18	56	03 410 107
3	184	3.0	145	4	18	98	03 410 109
*4	216	3.2	178	8	18	112	03 410 110
6	250	3.1	235	8	22	160	03 410 112

\*4† BS10 Table D has 4 holes and should be ordered as 03 409 11

### BS4504 Table 16/3-10/3

Size	A	B	P.C.D.	No. of Holes	Hole Diameter	gms	Code
1/2	95	3.0	65	4	14	31	03 408 102
3/4	112	3.0	75	4	14	37	03 408 103
1	115	3.0	85	4	14	37	03 408 104
1 <sup>1</sup> / <sub>4</sub>	121	3.0	100	4	18	41	03 408 105
1 <sup>1</sup> / <sub>2</sub>	133	3.0	110	4	18	55	03 408 106
2	153	3.0	125	4	18	56	03 408 107
3	184	3.0	160	8	18	98	03 408 109
4	216	3.2	180	8	18	112	03 408 110
6	280	3.1	240	8	22	160	03 408 112

### ANSI Class 150

Size	A	B	P.C.D.	No. of Holes	Hole Diameter	gms	Code
1/2	95	3.0	60	4	14	31	03 426 102
3/4	112	3.0	70	4	14	37	03 426 103
1	115	3.0	80	4	14	37	03 426 104
1 <sup>1</sup> / <sub>2</sub>	133	3.0	98	4	14	55	03 426 106
2	153	3.0	121	4	18	56	03 426 107
3	184	3.0	152	4	18	98	03 426 109
4	216	3.2	190	8	18	112	03 426 110
6	280	3.1	241	8	22	160	03 426 112

## Valve support plates Galvanised mild steel

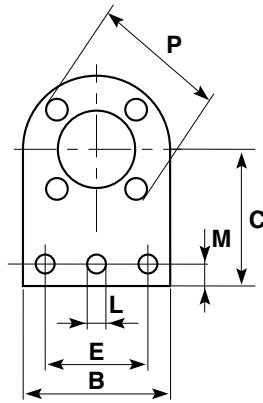

**BS4504 Table 16/3** (1/2" to 8") **10/3** (1/2" to 6")

Size	B	C	E	L	M	N	P	Weight gms	Code
1/2	95	86	50	14	16	2	65	370	03 458 102
3/4	106	89	75	14	16	2	75	450	03 458 103
1	143	99	75	14	16	2	85	560	03 458 104
1 1/4	152	105	75	14	16	2	100	950	03 458 105
1 1/2	151	105	74	14	16	2	110	1150	03 458 106
2	166	127	101	14	17	2	125	1380	03 458 107
2 1/2	185	144	125	14	22	2	145	2500	31 459 312
3	201	143	127	14	22	2	160	1650	03 458 109
4	222	161	151	14	24	3	180	2550	03 458 110
6	286	217	228	14	33	3	240	4100	03 458 112
8	340	242	280	14	31	3	295	6250	03 458 113

**N** = No. of holes in base.

## O-Rings

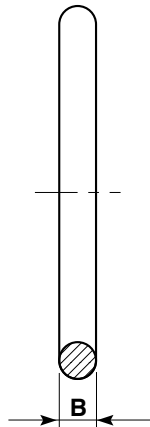

Size	B	gms	EPDM Code	FPM Code
3/8	3.5	0.5	03 209 101	03 211 101
1/2	3.5	1	03 209 102	03 211 102
3/4	3.5	2	03 209 103	03 211 103
1	3.5	3	03 209 104	03 211 104
1 1/4	5.2	5	13 209 309	03 211 105
1 1/2	5.2	6	13 209 310	03 211 106
2	5.3	7	03 306 107	03 211 107

## Valves

### VKD Double union ball valves Manual – EPDM seals

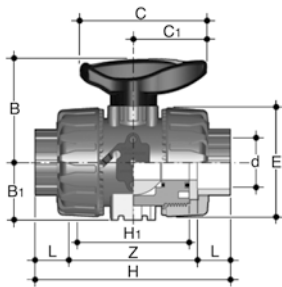

d	DN	PN	L	Z	H	E	B	C	gms	Code
3/8	10	16	14.5	74	103	55	49	66	160	HO DKA 101
1/2	15	16	16.5	70	103	55	49	66	160	HO DKA 102
3/4	20	16	19	77	115	66	59	75	265	HO DKA 103
1	25	16	22.5	83	128	75	66	85	345	HO DKA 104
1 1/4	32	16	26	94	146	87	75	97	550	HO DKA 105
1 1/2	40	16	30	104	164	100	87	110	730	HO DKA 106
2	50	16	36	127	199	122	101	134	1280	HO DKA 107

Options:

FPM seals (plain ends) order HO DKB\*\*\*

FPM seals (threaded ends) order HO DKB\*\*\*

Manual valves can be supplied with locking kits - further information is available from our Valve Department.

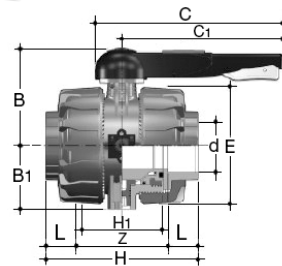

d	DN	PN	Z	L	H	H <sub>1</sub>	E	B	B <sub>1</sub>	C	C <sub>1</sub>	gms	Code
2 1/2	65	16	147	44	235	133	164	164	87	225	175	3725	HO DKA 312
3	80	16	168	51	270	149	203	177	105	327	272	5700	HO DKA 109
4	100	16	186	61	308	167	238	195	129	385	330	8660	HO DKA 110

Options:

FPM seals (plain ends) order HO DKB\*\*\*

### TKD 3-way ball valves Manual – EPDM seals

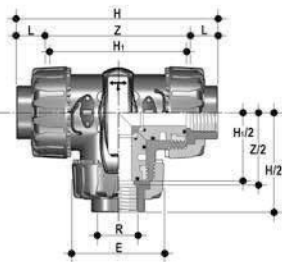
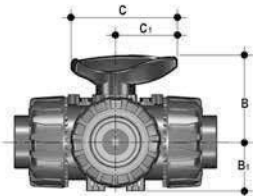

T-Port design

d	DN	PN	H	Z	C	C <sub>1</sub>	B	B <sub>1</sub>	gms	Code
1/2	15	16	125	95	67	40	54	29	235	HO TTA 102
3/4	20	16	146	114	85	49	65	34.5	415	HO TTA 103
1	25	16	166	129	85	49	65.9	39	570	HO TTA 104
1 1/4	32	16	195.5	151	108	64	82.5	46	895	HO TTA 105
1 1/2	40	16	211	166	108	64	89	52	1250	HO TTA 106
2	50	16	253.5	199	134	76	108	62	2225	HO TTA 107

Options:

FPM seals (plain ends) order HO TTB\*\*\*

FPM seals (threaded ends) order HO TTB\*\*\*

Manual valves can be supplied with locking kits - further information is available from our Valve Department.

L-Port design

d	DN	PN	H	Z	C	C <sub>1</sub>	B	B <sub>1</sub>	gms	Code
1/2	15	16	125	95	67	40	54	29	235	HO LTA 102
3/4	20	16	146	114	85	49	65	34.5	415	HO LTA 103
1	25	16	166	129	85	49	65.9	39	570	HO LTA 104
1 1/4	32	16	195.5	151	108	64	82.5	46	895	HO LTA 105
1 1/2	40	16	211	166	108	64	89	52	1250	HO LTA 106
2	50	16	253.5	199	134	76	108	62	2225	HO LTA 107

Options:

FPM seals (plain ends) order HO LTB\*\*\*

VKD & TKD ball valves can be supplied electrically or pneumatically actuated.

## VXE Easyfit double union ball valves Manual – EPDM seals

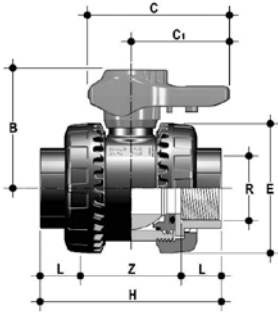

d	DN	PN	L	Z	H	E	B	C	C <sub>1</sub>	gms	Code
1/2	15	16	16.5	49	82	54	49	64	20	170	HO XEA 102
3/4	20	16	19	53	91	63	62	78	23	252	HO XEA 103
1	25	16	22.5	58	103	72	71	87	27	354	HO XEA 104
1 1/4	32	16	26	68	120	85	82	102	30	548	HO XEA 105
1 1/2	40	16	30	79	139	100	92	109	33	771	HO XEA 106
2	50	16	36	102	174	118	110	133	39	1285	HO XEA 107

Options:

EPDM seals (threaded ends) order HO XEA B\*\*

FPM seals (plain ends) order HO XEB \*\*\*



## VKR Metering ball valves Manual – EPDM seals

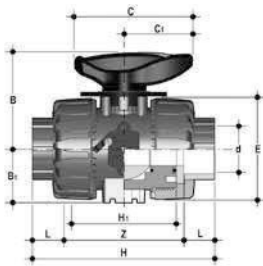

d	DN	PN	L	Z	H	H <sub>1</sub>	E	B	B <sub>1</sub>	C	C <sub>1</sub>	gms	Code
3/8	10	16	16.5	70	103	65	54	54	29	67	40	205	HO MBA 101
1/2	10	16	16.5	70	103	65	54	54	29	67	40	205	HO MBA 102
3/4	20	16	19	77	115	70	65	65	34.5	85	49	335	HO MBA 103
1	25	16	22.5	83	128	78	73	70	39	85	49	433	HO MBA 104
1 1/4	32	16	26	94	146	88	86	83	46	108	64	703	HO MBA 105
1 1/2	40	16	30	104	164	91	98	89	52	108	64	925	HO MBA 106
2	50	16	36	127	199	111	122	108	62	134	76	1577	HO MBA 107

Options:

FPM seals (plain ends) order HO MBB \*\*\*

## SX Easyfit ball check valves Plain ends – EPDM seals (other options available)



d	DN	PN	L	Z	H	E	gms	Code
1/2	15	16	16.5	50	82	54	133	HO SXA 102
3/4	20	16	19	53	91	63	171	HO SXA 103
1	25	16	22.5	59	103	72	270	HO SXA 104
1 1/4	32	16	26	68	120	85	414	HO SXA 105
1 1/2	40	16	30	77	139	100	608	HO SXA 106
2	50	16	36	98	174	118	972	HO SXA 107

Options:

EPDM seals (threaded ends) order HO SXA B\*\*

FPM seals (plain ends) order HO SXB\*\*\*

FPM seals (threaded ends) order HO SXB B\*\*

**Note:** this valve must be installed at a minimum distance of 10 x nominal diameter (eg. 20" for size 2") from pump flange.

## SA Easyfit air release valves Plain ends – EPDM seals (other options available)



d	DN	PN	L	Z	H	E	gms	Code
1/2	15	16	16.5	50	82	54	133	H0 SAA 102
3/4	20	16	19	53	91	63	171	H0 SAA 103
1	25	16	22.5	59	103	72	270	H0 SAA 104
1 1/4	32	16	26	68	120	85	414	H0 SAA 105
1 1/2	40	16	30	77	139	100	608	H0 SAA 106
2	50	16	36	98	174	118	972	H0 SAA 107

Options:

EPDM seals (threaded ends) order H0 SAA B\*\*

FPM seals (plain ends) order H0 SAB\*\*\*

FPM seals (threaded ends) order H0 SAB B\*\*

## RV Y-Type strainers Plain ends – EPDM seals

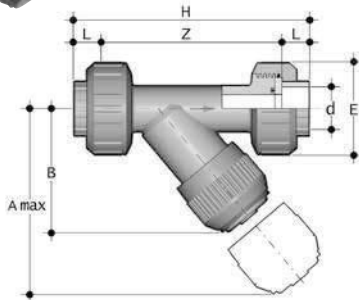

d	DN	PN	A	B	E	L	Z	H	Fig.	gms	Code	
			Grey	max								
1/2	15	15	125	72	55	16	103	135	A	211	H0 UVA 102	
3/4	20	15	145	84	66	19	120	158	A	358	H0 UVA 103	
1	25	15	165	95	75	22	132	176	A	526	H0 UVA 104	
1 1/4	32	15	190	111	87	26	155	207	A	733	H0 UVA 105	
1 1/2	40	15	210	120	100	31	181	243	A	1095	H0 UVA 106	
2	50	9	240	139	120	38	222	298	A	1843	H0 UVA 107	

Options:

EPDM seals (threaded ends) order H0 RVA B\*\*

FPM seals (plain ends) order H0 RVB\*\*\*

FPM seals (threaded ends) order H0 RVB B\*\*

## Dialock® diaphragm valves Manual – plain union ends – EPDM seals

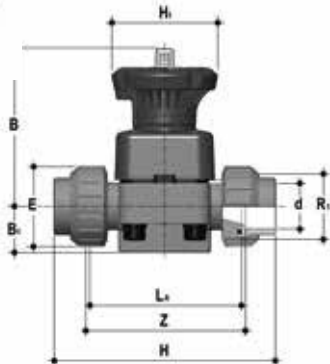

d	DN	PN	B	B <sub>1</sub>	E	H	H <sub>1</sub>	L <sub>A</sub>	Z	gms	Code
1/2	15	10	102	25	41	143	80	90	98	420	H0 DVA 102
3/4	20	10	105	30	50	167	80	108	115	473	H0 DVA 103
1	25	10	114	33	58	180	80	116	122	665	H0 DVA 104
1 1/4	32	10	119	30	72	208	80	134	144	770	H0 DVA 105
1 1/2	40	10	147	35	79	234	120	154	164	1460	H0 DVA 106
2	50	10	172	46	98	272	120	184	195	2340	H0 DVA 107

Options:

FPM diaphragm order H0 DVB\*\*\*

PTFE diaphragm order H0 DVC\*\*\*

Travel stop and stroke limiter options available upon request.

## Pressure loading/relief valves EPDM seals

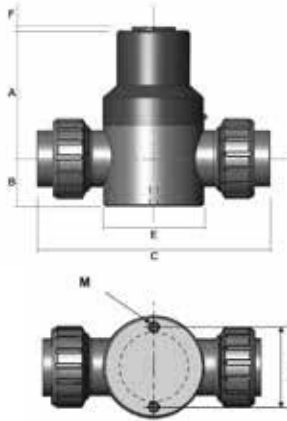

Size	DN	PN	A	B	C	D	E	F	M	gms	Code
1/2	10	10	85	26	133	40	52	3	M5	101	HO LRA 102
3/4	15	10	85	26	133	40	52	3	M5	101	HO LRA 103
1	20	10	102	33	153	50	64	3	M5	257	HO LRA 104
1 1/4	25	10	105	35	174	60	79	3	M6	425	HO LRA 105
1 1/2	30	10	113	42	204	70	89	3	M6	607	HO LRA 106
2	50	10	153	57	291	100	126	6	M6	1444	HO LRA 107

\*Max (3 Bar loading) (10 Bar relief)

Options:

FPM options order HO LRB\*\*\*

PTFE options order HO LRC\*\*\*

## FK Butterfly valves Glass reinforced polypropylene with ABS disc and EPDM seals

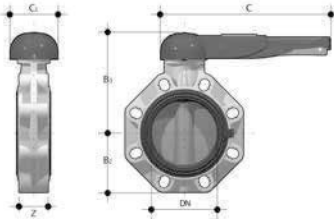

lever operated

Size	DN	PN	B <sub>2</sub>	B <sub>3</sub>	C	C <sub>1</sub>	Z	gms	U	Code
1 1/2	40	15	60	137	175	100	33	900	4	HO FKA 106
2	50	15	70	143	175	100	43	1080	4	HO FKA 107
2 1/2	65	9	80	164	272	110	46	1470	4	HO FKA 108
3	80	9	93	178	272	110	49	1870	8	HO FKA 109
4	100	9	107	192	272	110	56	2220	8	HO FKA 110
5	125	9	120	212	330	110	64	3100	8	HO FKA 111
6	150	9	134	225	330	110	70	3850	8	HO FKA 112
8	200	9	161	272	420	122	71	6750	8	HO FKA 113

Options:

FPM seals order HO FKB\*\*\*

U = No. of holes

with gear box

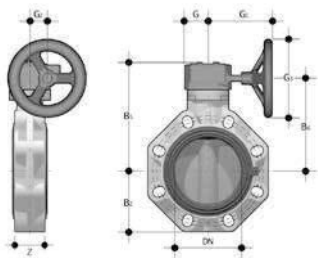

Size	DN	PN	B <sub>2</sub>	B <sub>5</sub>	B <sub>6</sub>	G	G <sub>1</sub>	G <sub>2</sub>	G <sub>3</sub>	Z	gms	U	Code
2 1/2	65	9	80	174	146	48	135	39	125	46	2400	4	HV FKA 108
3	80	9	93	188	160	48	135	39	125	49	2800	8	HV FKA 109
4	100	9	107	202	174	48	135	39	125	56	3150	8	HV FKA 110
5	125	9	120	222	194	48	144	39	200	64	4450	8	HV FKA 111
6	150	9	134	235	207	48	144	39	200	70	5200	8	HV FKA 112
8	200	9	161	287	256	65	204	60	200	71	9300	8	HV FKA 113
10	250	10	210	317	281	88	236	76	250	114	18600	12	HV FKA 114
12	300	8	245	374	338	88	236	76	250	114	25600	12	HV FKA 115

Options:

FPM seals order HV FKB\*\*\*

U = No. of holes

**Note:** Lugged versions available to special order. Please refer to our Valve Department for further details.

Our valve range can be electrically or pneumatically actuated.  
For further details contact our Valve Department on 01543 471681.

## Accessories

### One-step solvent cement



Litres	gms	Code
0.5	550	03 461 395
1.0	1100	03 461 396

Only Durapipe ABS solvent cement and Durapipe Eco-cleaner should be used for jointing of Durapipe ABS pipework systems.

### Eco-cleaner



Litres	gms	Code
0.5	500	03 457 395

Only Durapipe ABS solvent cement and Durapipe Eco-cleaner should be used for jointing of Durapipe ABS pipework systems.

### Cobra pipe clips Polypropylene

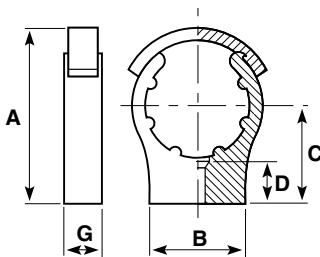

Size	A	B	C	D	G	Bolt/Screw size	gms	Code
3/8	-	35	25	19	16	M.4/3BA/No 8	7	13 434 305
1/2	-	35	30	14	16	M.5/1BA/No 10	8	13 434 306
3/4	-	35	35	16	17	M.5/1BA/No 10	11	13 434 307
1	-	40	40	17	17	M.5/1BA/No 10	14	13 434 308
1 1/4	75	45	45	20	20	M.5/1BA/No 10	21	13 434 309
1 1/2	85	50	50	22	21	M.6/0BA/No 10	30	13 434 310
2	102	60	60	19	21	M.6/0BA/No 10	42	13 434 311
2 1/2	122	70	70	27	31	M.8	94	13 434 312
3	148	80	90	39	31	M.8	121	13 434 313
4	171	90	96	36	35	M.8	185	13 434 314
5	211	156	132	40	40	M.8	252	13 434 316
6	243	170	150	40	40	M.8	330	13 434 317

Clips of size 1 1/4" and above are fitted with retaining strap.  
Bolts/screws not supplied.

### Saddle clips Polypropylene

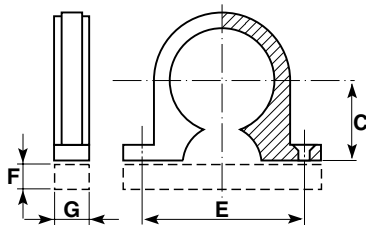

Size	C	E	F	G	Bolt/Screw size	gms	Code
3/8	13	37	-	14	M.4/3BA/No 8	3	03 455 101
1/2	18	41	-	14	M.4/3BA/No 8	4	03 455 102
3/4	21	45	-	16	M.5/2BA/No 10	6	03 455 103
1	23	56	-	16	M.5/2BA/No 10	7	03 455 104
1 1/4	29	65	-	16	M.5/2BA/No 10	11	03 455 105
1 1/2	34	67	-	16	M.5/2BA/No 10	12	03 455 106
2	38	87	-	22	M.6/0BA/No 12	25	03 455 107
3	50	122	8	34	M.10/3/8UNC	45	03 455 109
4	65	156	13	38	M.10/3/8UNC	70	03 455 110

Backing plate shown dotted supplied with 3" and 4" only.  
Bolts/screws not supplied. Bolt holes in 3" and 4" clips are not countersunk.



## Chamfering and de-burring tools

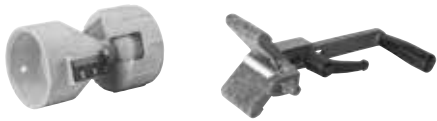

Description	Product code
3/8" to 2" pipe inner and outer milling cutter tool	FT 55 65 12
3/4" to 6" chamfering tool	FT 55 05 10

## Pipe cutters



Description	Product code
3/8" to 2" pipe cutter	FT 80 00 01
1 1/2" to 4" pipe cutter	FT 80 00 03
3/8" to 2" spare cutter wheel	FT 80 00 02
1 1/2" to 4" spare cutter wheel	FT 80 00 04

## Fibre Seal tape



Description	Product code
Sealing tape for threaded connections	03 469 395

# Product Specification

## METRIC RANGE

### DURAPIPE SuperFLO ABS PIPES

KIWA 49, ISO 161/1, and ISO DIS 15493 (where applicable). Pressure rating PN10 at 20°C up to 250 mm. PN8 at 20°C for 315 mm.

### DURAPIPE SuperFLO ABS FITTINGS

KIWA 549, ISO 727 and ISO DIS 15493 (where applicable). Pressure rating PN10 at 20°C up to 250 mm. PN8 at 20°C for 315 mm.

### MATCHED SYSTEM

The ABS products shall be from a single manufacturer to ensure complete integrity, quality and compatibility between pipes, fittings and valves. Manufacturer's warranties may be compromised if a system is installed with materials from various manufacturers. Where this is not possible then any alternative products should be confirmed as being at least equivalent to that which is normally supplied.

### QUALITY SYSTEM

Pipes, fittings and valves shall be manufactured in an environment which operates a Quality Assurance System assessed to ISO 9001.

### ENVIRONMENTAL SYSTEM

The manufacturer of pipes, fittings, and valves shall be able to demonstrate compliance with applicable environmental legislation and products shall be manufactured in an environment where documented performance reviews are undertaken and an Environmental Management System is successfully assessed to ISO 14001.

The manufacturer shall offer ABS solvent cements and cleaners, specially formulated to minimise any adverse effects on the environment during installation of the ABS system.

### THIRD PARTY APPROVALS

The manufacturer shall have the following Third Party Approvals:

#### WRAS Water Regulations Advisory Scheme

1505040 - Durapipe SuperFLO ABS Metric Pipe and Fittings  
1509035 - Durapipe SuperFLO ABS VKD and VKR Ball Valves

### APPROVAL FOR USE IN CONTACT WITH DRINKING WATER

All ABS pipes, fittings and solvent cement shall be listed in the Water Fittings and Materials Directory to show compliance with the requirements of the United Kingdom Water Regulations Advisory Service.

Copies of certification of compliance with these approvals are available for inspection.

Durapipe SuperFLO ABS is also approved for use within public water supplies and by the secretary of state. Durapipe SuperFLO ABS is listed in the "List of Approved Products" published by the DWI.

### MARINE APPROVALS

American Bureau of Shipping  
Bureau Veritas  
Germanischer Lloyd  
Det Norske Veritas  
Lloyds register UK  
RINA (Royal Institution of Naval Architects)  
Russian Marine register

### DESIGN LIFE

Pipes and fittings shall be designed to operate continuously for 50 years at their maximum rated pressure at a working temperature of 20°C. Valves are designed to operate continuously for 25 years at a working temperature of 20°C.

Process Control Testing must be carried out during manufacture and documented on each and every production batch.

Fittings and Pipes will be subjected to a pressure test of 3.2 x maximum recommended working pressure for 1 hour at 20°C during 1st and 2nd hours of production, then every 6 hours for fittings and 8 hours for pipes.

Pipes are in addition to be impact tested after conditioning at 0°C for 1 hour.

Fittings are in addition to be subject to stress relief testing at 150°C.

Pipes and fittings shall undergo dimensional, marking, and visual inspection at the frequency outlined above.

### CHEMICAL SUITABILITY

The manufacturer shall publish detailed chemical resistance data to enable the suitability of the ABS material, seals, and gaskets to be determined by designers and specifiers.

The manufacturer shall also employ a qualified and experienced Chemist and provide a free-of-charge advisory service for assessing the suitability of its ABS material, seals, and gaskets.

### INSTALLATION SPECIFICATION

The installation must be carried out by competent persons.

The contractor shall be required to provide technical documentation relating to the manufacturer's recommended Installation procedures.

The manufacturer shall publish Installation recommendations, and shall also provide a free-of-charge training service for designers and installers, with appropriate written confirmation of attendance.

### DURAPIPE SuperFLO ABS BALL VALVES

True union design, end load resistant with full pressure and shock resistant anti blow out device which conforms to design and endurance testing requirements of BS 5392 Part 1 1976, and DIN 3230 Part 3 Leak Rate One (Water and Air).

The following testing will have been successfully completed:

Drop Tight and Bubble Tight test

Hydrostatic Shell Test 1.5 x maximum working pressure

Seat Test 1.1 x maximum working pressure

### PRESSURE RATING

16mm to 63mm - PN 16 at 20°C (VKD series), PN10 (VXE series)

75mm to 110mm - PN16 at 20°C (VKD series)

### SEATS AND SEALS

Seats: PTFE material fitted with O-Ring compensators

Seals: Standard size O-Ring type for ease of replacement

Available in EPDM or FPM materials

### END CONNECTIONS

Plain socket ends or BSP threaded

### ACTUATION

Options: Electric or Pneumatic

### DURAPIPE SuperFLO ABS DIAPHRAGM VALVES

Equipped with a maintenance free hand wheel for operation, complete with a built in locking mechanism and optical positioning indicator as standard. The body retaining bolts are fixed from the underside, to provide a crevice free outer surface to prevent accumulation of debris or risk of corrosion of exposed steel bolts from chemical spillage.

Valves will have been hydrostatically pressure tested to the requirements of BS 5392 Part 1 1976, BS 5156, ISO 7508 and DIN 3230 Part 3 Leak Rate One.

### PRESSURE RATING

20mm to 110mm - PN10 at 20°C

### DIAPHRAGM TYPE

Choice of EPDM, FPM or PTFE will be available

### END CONNECTION

These may be plain, spigot ends or flanged

### ACTUATION

Options: Pneumatic

### DURAPIPE SuperFLO ABS BALL CHECK VALVES

These shall be double union with plain socket or BSP threaded ends.

### PRESSURE RATING

20mm to 63mm - PN10 at 20°C

### SEALS

Available in either EPDM or FPM

### DURAPIPE SuperFLO ABS BUTTERFLY VALVES

Reinforced Polypropylene body, fully lined, with ABS disc.

Full flanged design, with oval holes/inserts to suit various standard flange drillings.

Lever operated, with 10 x 10° position stops, and locking device

### PRESSURE RATING

50mm to 250mm - PN9 at 20°C

315mm - PN 8 at 20°C

### PRIMARY LINER

Available in EPDM, FPM, or NBR

### ACTUATION

Electric, Pneumatic, or Gearbox (standard on sizes over 225mm)

## IMPERIAL RANGE

### DURAPIPE SuperFLO ABS PIPES

In accordance with the dimensional and testing requirements of BS 5391 Third Party Approved with British Standard Kitemark Licence (where applicable).

### DURAPIPE SuperFLO ABS FITTINGS

In accordance with the dimensional and testing requirements of BS 5392 Third Party Approved with British Standard Kitemark Licence (where applicable).

### MATCHED SYSTEM

The ABS products (see below) shall be from a single manufacturer to ensure complete integrity, quality and compatibility between pipes, fittings and valves. Manufacturer's warranties may be compromised if a system is installed with materials from various manufacturers. Where this is not possible then any alternative products should be confirmed as being at least equivalent to that which is normally supplied.

### QUALITY SYSTEM

Pipes, fittings and valves shall be manufactured in an environment, which operates a Quality Assurance System assessed to ISO 9001.

### ENVIRONMENTAL SYSTEM

The manufacturer of pipes, fittings and valves shall be able to demonstrate compliance with applicable environmental legislation and products shall be manufactured in an environment where documented performance reviews are undertaken and an Environmental Management System is successfully assessed to ISO 14001.

The manufacturer shall offer ABS solvent cements and cleaners, specially formulated to minimise any adverse effects on the environment during installation of the ABS system.

### THIRD PARTY APPROVALS

The manufacturer shall have the following Third Party Approvals:

#### British Standard Kitemark Licence

KM07961 for Durapipe Inch pipes to BS 5391  
KM07962 for Durapipe Inch fittings to BS 5392

#### WRAS Water Regulations Advisory Scheme

1212103 - Durapipe SuperFLO ABS Imperial Pipe and Fittings  
1509035 - Durapipe SuperFLO ABS VKD and VKR Ball Valves

#### Department of the Environment

M & E 100 Standard Specification for Air Conditioning

### MARINE APPROVALS

American Bureau of Shipping

### APPROVAL FOR USE IN CONTACT WITH DRINKING WATER

All ABS pipes, fittings and solvent cement shall be listed in the Water Fittings and Materials Directory to show compliance with the requirements of the United Kingdom Water Regulations Advisory Service. Copies of certification of compliance with these approvals are available for inspection.

### DESIGN LIFE

Pipes, fittings and valves shall be designed to operate continuously for 50 years at their maximum rated pressure at a working temperature of 20°C.

Process Control Testing must be carried out during manufacture and documented on each and every production batch.

Fittings and Pipes will be subjected to a pressure test of 3.2 x maximum recommended working pressure for 1 hour at 20°C during 1st and 2nd hours of production, then every 6 hours for fittings, and 8 hours for pipes.

Pipes are in addition to be impact tested after conditioning at 0°C for 1 hour.

Fittings are in addition to be subject to stress relief testing at 150°C.

Pipes and fittings shall undergo dimensional, marking and visual inspection at the frequency outlined above.

### CHEMICAL SUITABILITY

The manufacturer shall publish detailed chemical resistance data to enable the suitability of the ABS material, seals and gaskets to be determined by designers and specifiers.

The manufacturer shall also employ a qualified and experienced chemist and provide a free-of-charge service advisory service for assessing the suitability of its ABS material, seals and gaskets.

### INSTALLATION SPECIFICATION

The installation must be carried out by competent persons.

The contractor shall be required to provide technical documentation relating to the manufacturer's recommended Installation procedures.

The manufacturer shall publish Installation recommendations, and shall also provide a free-of-charge training service for designers and installers, with appropriate written confirmation of attendance.

### DURAPIPE SuperFLO ABS BALL VALVES

True union design, end load resistant with full pressure and shock resistant anti blow out device which conforms to design and endurance testing requirements of BS 5392 Part 1 1976, and DIN 3230 Part 3 Leak Rate One (Water and Air).

The following testing will have been successfully conducted:

Drop Tight and Bubble Tight test.

Hydrostatic Shell Test 1.5 x Maximum Working Pressure.

Seat Test 1.1 x Maximum Working Pressure.

#### PRESSURE RATING

Up to size 2" - PN15 (Class E) at 20°C (VKD series), PN10 (VXE series)  
2½" to 4" - PN15 at 20°C (VKD series)

#### SEATS AND SEALS

Seats: PTFE material fitted with O-Ring compensators

Seals: Standard size O-Ring type for ease of replacement

Available in EPDM or FPM materials

#### END CONNECTIONS

Plain socket ends, or BSP threaded

#### ACTUATION

Options: Electric or pneumatic

### DURAPIPE SuperFLO ABS DIAPHRAGM VALVES

Equipped with a maintenance free hand wheel for operation, complete with a built in locking mechanism and optical positioning indicator as standard. The body retaining bolts are fixed from the underside, to provide a crevice free outer surface to prevent accumulation of debris or risk of corrosion of exposed steel bolts from chemical spillage.

Valves will have been hydrostatically pressure tested to the requirements of BS 5392 Part 1 1976, BS 5156, ISO 7508 and DIN 3230 Part 3 Leak Rate One.

#### PRESSURE RATING

½" to 4" - PN9 at 20°C

#### DIAPHRAGM TYPE

Choice of EPDM, FPM or PTFE will be available

#### END CONNECTION

These may be plain, spigot ends or flanged

#### ACTUATION

Options: Pneumatic

### DURAPIPE SuperFLO ABS BALL CHECK VALVES

These shall be double union with plain socket or BSP threaded ends.

#### PRESSURE RATING

½" to 2" - PN10 at 20°C

#### SEALS

Available in either EPDM or FPM

### DURAPIPE SuperFLO ABS BUTTERFLY VALVES

Reinforced Polypropylene body, fully lined, with ABS disc.

Full flanged design, with oval holes/inserts to suit various standard flange drillings. Lever operated, with 10 x 10° position stops, and locking device.

#### PRESSURE RATING

1½" to 10" - PN9 at 20°C

12" - PN8 at 20°C

#### PRIMARY LINER

Available in EPDM, FPM, or NBR

#### ACTUATION

Electric, Pneumatic, or Gearbox (standard on sizes over 8")



## Company History

In 2014, we celebrated our 60th anniversary. This landmark event allowed us to proudly reflect on our rich history of innovation and high-quality manufacturing of plastic pipework systems.

During this period of time, our business has visibly changed and evolved dramatically from the company that was originally started in West Drayton, primarily to manufacture low density polyethylene pipe back in 1954.

Product innovation and development within plastic pipework has remained at the core of our operation over the last 60 years, with our customers being the mainstay of our business and its progression from the outset.

### A brief history of Durapipe follows:

- 1954 Durapipe and Fittings Ltd is formed in West Drayton and moves into the emerging thermoplastic industry
- 1960 Featured in Financial Times for supplying pipework to South Africa for construction of gold mines
- 1961 Founder member of plastics pipe society
- 1962 1st UK pipe manufacturer to exhibit at New York plastics exposition show
- 1971 Durapipe re-locates to Cannock, Staffs and begins manufacturing from the current site
- 1974 Air-line Xtra brand is launched for compressed air due to lack of steel pipes during the 3-day working week
- 1981 Glynwed purchases Durapipe and other international companies and Glynwed International is named
- 1987 FIP is acquired by Glynwed & FIP valves are added to the range
- 1993 Durapipe Petrol-line (PLX) is launched
- 1993 Durapipe piping is supplied to provide continual spray to the Mary Rose restoration project
- 1996 Vulcathene is combined into Durapipe S&LP
- 2001 Etex (later becoming Aliaxis) purchases Glynwed Pipesystems (Durapipe)
- 2006 New VKD range of ball valves are launched
- 2007 Durapipe SuperFLO is supplied for air conditioning at British Museum in London
- 2008 Durapipe PLX is supplied as part of the construction of the Beijing Olympics
- 2010 Durapipe Guardian dual contained PVC-U pipework is launched
- 2013 Durapipe launches HTA system for hot & cold water
- 2015 Durapipe launches range of clear PVC pipe



# Actuated Valves

In addition to our extensive range of manual valves we also offer a wide range of actuated valve solutions, that can be either electrically or pneumatically operated.

## Actuated Valves

Actuated valves provide the user with the ability to operate a process or a series of actions remotely, removing the need for manual operation; the user can manage a network of valves via various methods of electronic signal controls

At Durapipe, we offer an extensive range of actuated valve solutions in a selection of sizes, combining our leading manual valve offering with electric or pneumatic powered actuators suitable for a wide range of processes and applications.

Electric and Pneumatic actuation can both prove advantageous to the user depending on the application and the availability of a reliable power source or compressed air at the point of use.



### Actuated Valve Options

- VKD DualBlock® Ball Valve
- TKD DualBlock® 3 Way Ball Valve
- VKR Metering Ball Valve
- FK Butterfly Valve
- Dialock Diaphragm Valve
- CM Compact Diaphragm Valve



### Actuator Options

#### Electric Actuation

- 100 to 240vAC
- 24vAC/DC

#### Options

- Standard(On/Off)
- Fail Safe Open
- Fail Safe Closed
- 4 to 20mA Positioning

#### Pneumatic Actuation

- Compressed Air

#### Options

- Fail Safe Open
- Fail Safe Closed
- Double Acting
- Positioning Options

At Durapipe UK, our dedicated Valve & Actuation Team can offer technical advice and assemble complex valve packages, which can usually be delivered to site within 48 hours.

For further information please contact  
01543 471681.

## Durapipe UK Pipework Systems



### Air-Line Xtra

- High performance thermoplastic pipework system for compressed air applications
- Offering an ideal solution ensuring that compressed air is kept clean and uncontaminated for use in various industries

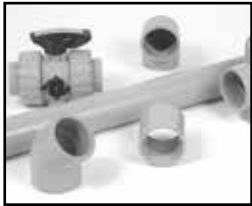

### Corzan

- Solvent weld thermoplastic pipe system for aggressive substances
- Designed specifically for use in highly corrosive conditions at temperatures up to 95°C
- Valves range available



### Friaphon

- Sound attenuated drainage system
- Superb sound insulation with no lagging required
- Ideal for hospitals, hotels, office suites and apartments



### Guardian

- Specialist dual contained pipework
- Patented Centra-Lok™ system
- Visual or automated leak detection system available



### HTA

- Pipe system for hot & cold water
- Limescale & corrosion resistant
- Installed cost savings vs traditional materials



### PLX

- Purpose designed for safe fuel transfer
- Suitable for pressure and vacuum applications
- Resists fuel permeation



### Polypropylene

- Conveys chemicals at temperatures up to 100°C
- Excellent resistance to a wide range of substances
- Available in larger diameters up to 500mm
- Full range of valves



### PVC-U

- Versatile, multi-purpose solvent weld pipework system with an extensive range of valves and fittings
- The established system for process and industrial handling of chemicals and water up to 60°C
- Guardian dual contained PVC-U pipework system



### Valves & Flow Control

- Actuated valves and FLS flow control solutions
- Offering a fully matched system
- Lightweight and easy to install



### Vulcathene

- Safe chemical drainage
- Two easy jointing methods - Mechanical or Enfusion
- Ideal for schools, universities and colleges, hospitals and clinics, pharmaceutical and research organisations

## DURAPIPE UK CONDITIONS OF SALE

1. **DEFINITIONS:**  
 'Seller' shall mean Glynwed Pipe Systems Limited, registered in England under number 1698059. 'Buyer' shall mean any company, organisation or individual to whom a quotation is offered, or whose order is accepted by the Seller.
2. **CONDITIONS:**  
 All offers, quotations, estimates, acceptances and contracts are subject to these Conditions of Business and any terms or conditions which any other person shall seek to impose or make part of any contract shall, so far as is inconsistent with these Conditions of Business, not apply unless expressly agreed by the Seller in writing. The headings in these conditions are for convenience only and shall not affect their interpretation.
3. **QUOTATIONS AND PRICE VARIATION:**
  - a) Any quotation given by the Seller is an invitation to the Buyer to make an offer only and no order of the Buyer placed with the Seller in pursuance of a quotation or otherwise shall be binding on the Seller unless and until it is accepted in writing by the Seller.
  - b) Unless stated otherwise, all quotations and published price lists are ex works, exclusive of VAT and shall remain valid for 30 days or such a period as may be quoted but nevertheless the Seller may amend or withdraw any quotation by written or oral notice. Quotations may be varied if the Buyer makes variations in his specifications.
  - c) Certain products are denoted 'MTO' in the Seller's published price lists. These products are Made to Order Goods and the Seller manufactures or procures these goods on a bespoke basis only. Where a Buyer has made an offer for 'MTO' products that the Seller has accepted in writing the Buyer forfeits their right to cancel their offer unless the Seller confirms in writing that it will accept cancellation by the Buyer. Where the Seller does not provide written confirmation of the Buyer's cancellation the Buyer remains liable for the full contractual value of all 'MTO' products. 'MTO' 'Call-Off' orders must be taken within 12 months of the original order date.
4. **STATEMENTS OR REPRESENTATIONS TO THE BUYER:**  
 If any statement or representation has been made to the Buyer upon which the Buyer relies other than in the documents enclosed with the Seller's quotation, the Buyer must set out that statement or representation in a document to be attached to or endorsed on the order in which case the Seller may submit a new quotation.
5. **DELIVERY - TIME:**
  - a) Any period for delivery given at any time and in any manner by the Seller is an estimate only and is not binding on the Seller. Delivery periods are normally calculated from the later of:
    - i) acceptance of order; or
    - ii) where applicable, the receipt by the Seller of a detailed specification or drawings.
  - b) Time shall not be deemed to be of the essence of the contract. Failure by the Seller to meet any quoted delivery period for any part or the whole of the order shall not entitle the Buyer to rescind the contract or to claim damages of any nature.
  - c) The Seller will endeavour to comply with reasonable requests by the Buyer for postponement of delivery but shall be under no obligation to do so. Where delivery is postponed otherwise than due to default by the Seller the Buyer shall pay all costs and expenses including a reasonable charge for storage and transportation occasioned thereby and an extra charge for split delivery if applicable.
  - d) The Buyer will receive delivery of any consignment between the hours of 8.00am and 4.00pm Monday to Friday inclusive, unless otherwise agreed in writing. Cost incurred by the Seller arising from the Buyer's refusal to accept consignments within the agreed hours shall be borne by the Buyer.
6. **DELIVERY AND RISK:**
  - a) Except where stated to the contrary in the contract, delivery shall be made as follows:
    - i) where the Buyer provides the transport, delivery shall be made ex the Seller's works;
    - ii) where the Seller provides the transport, delivery shall be made to the premises of the Buyer, or the premises of the Buyer's customer or works site if the Buyer has requested delivery to be so made but where the Buyer has made such a request the Seller will make a first delivery to the Buyer's customer or works site as so much of the goods as is available for that delivery but subsequent deliveries will be made to the premises of the Buyer.
  - b) The Seller may at its discretion make partial delivery of orders and invoice the same.
  - c) Risk in the goods shall pass on delivery.
  - d) Where goods are sent FOB the Seller's responsibility shall cease when the goods are placed on board ship or aircraft without the need for the Seller to give notice to the Buyer and the provisions of Section 32(3) of the Sale of Goods Act 1979 shall not apply.
7. **OWNERSHIP OF GOODS:**
  - a) The goods shall remain the sole and absolute property of the Seller as legal and equitable owner until such time as the Buyer shall have paid to the Seller the contract price together with the full price of any other goods the subject of any contract between the Seller and the Buyer.
  - b) The Buyer acknowledges that until such time as the property in the goods passes to the Buyer he is in possession of the goods as a bailee and fiduciary agent for the Seller and the Purchaser shall store the goods in such a manner that they are clearly identifiable as the property of the Seller.
  - c) Until payment due under all contracts between the Buyer and the Seller had been made in full, in the event of sale of the goods by the Buyer:
    - i) the Seller shall be entitled to trace all proceeds of sale received by the Buyer through any bank or other account maintained by the Buyer; and
    - ii) the Buyer shall if requested by the Seller in writing to so assign its rights to recover the selling price of the goods from the third parties concerned. Such monies to be held separately by the Buyer as agent on behalf of the Seller.
  - d) The Seller may for the purpose of recovery of its goods enter upon any premises where they are stored or where they are reasonably thought to be stored and may repossess the same.
8. **TERMS OF PAYMENT:**  
 In the event of default in payment according to the agreed payment terms between the Seller and the Buyer – ie: by the end of the month following the month of despatch of the goods the Seller shall be entitled without prejudice to any other right or remedy to suspend all further deliveries and to charge interest on any amount outstanding at the rate of 2% per month until payment in full is made (a part of a month being treated as a full month for the purpose of calculating interest).
9. **SHORTAGES AND DEFECTS APPARENT ON DELIVERY:**
  - a) It shall be the responsibility of the Buyer to inspect or arrange for an inspection of the goods on delivery whether the goods are delivered to the Buyer's premises or to the premises of the Buyer's customer or to a works site. If no such inspection is made the Buyer shall be deemed to have accepted the goods.
  - b) The Buyer shall have no claim for shortages or defects apparent on inspection unless:
    - i) a written complaint is made to the Seller within three days of receipt of the goods specifying the shortage or defect; and
    - ii) the Seller is within seven days of receipt of the complaint given an opportunity to inspect the goods and investigate the complaint before any use is made of the goods.
  - c) If a complaint is not made to the Seller as herein provided then in respect of such shortages or defects the goods shall be deemed to be in all respects in accordance with the contract and the Buyer shall be bound to pay for the same accordingly.
10. **CLAIMS FOR DEFECTS NOT APPARENT ON INSPECTION:**
  - a) The Buyer shall have no claim for defects not apparent on inspection unless the Seller is notified of defective workmanship or materials within twelve months from delivery of the goods. Provided that the goods have been installed and applied in accordance with any relevant recommendations made by the Seller, the Seller will at its option replace the goods or refund the net invoiced price in respect of the goods which have been shown to be defective. If the Seller does so supply substitute goods the Buyer shall be bound to accept such substituted goods in full satisfaction of the obligations of the Seller under the contract.
  - b) The Buyer shall in any event have no claim or set-off in respect of defects unless a written complaint is sent to the Seller as soon as the defect is noticed and no use is made of the goods thereafter or alteration made thereto by the Buyer before the Seller is given an opportunity to inspect the goods.
  - c) The Buyer is responsible for ensuring that the goods are fit for any particular purpose, and no warranty or condition of fitness for any particular purpose is to be implied into the contract.
11. **LIABILITY:**  
 Save as stated in Conditions 9 and 10 (and save in respect of death or personal injury resulting from the negligence of the Seller its servants or agents) the Seller shall not be liable for any claim or claims for direct or indirect consequential or incidental injury loss or damage made by the Buyer against the Seller whether in contract or in tort (including negligence on the part of the Seller its servants or agents) arising out of or in connection with any defect in the goods or their fitness or otherwise for any particular purpose or any act omission neglect or default of the Seller its servants or agents in the performance of the contract.
12. **FORCE MAJEURE:**  
 Notwithstanding anything herein contained neither the Buyer nor the Seller is to be held liable for any delay or failure to carry out the contract due wholly or in part to an act of God action by any Government whether British or foreign civil war strikes and/or lockouts wheresoever occurring fire trade disputes floods or unfavourable weather or any material becoming unavailable or irreplaceable (whether at all or at commercially acceptable prices) or any other circumstances beyond the control of the Seller.
13. **SUB-CONTRACTING:**  
 The Seller reserves the right to sub-contract the fulfilment of any order or any part thereof.
14. **INSOLVENCY AND BREACH OF CONTRACT:**  
 In the event that:
  - a) the Buyer commits any breach of the contract and fails to remedy such breach (if capable of remedy) within a period of thirty days from receipt of a notice in writing from the Seller requesting such remedy; or
  - b) any distress or execution is levied upon any of the goods or property of the Buyer; or
  - c) the Buyer offers to make any arrangements with or for the benefit of its creditors or (if an individual) becomes subject to a petition for a bankruptcy order or (being a limited company) has a receiver appointed of the whole or any part of its undertaking property or assets; or
  - d) an order is made or a resolution is passed or analogous proceedings are taken for the winding up of the Buyer (save for the purpose of reconstruction or amalgamation with insolvency and previously approved in writing by the Seller) the Seller shall thereupon be entitled without prejudice to its other rights hereunder forthwith to suspend all further deliveries until the default has been made good or to determine the contract and any unfulfilled part thereof or at the Seller's option to make partial deliveries. Notwithstanding any such termination the Buyer shall pay to the Seller at the contract rate for all the goods delivered up to and including the date of termination.
15. **INDUSTRIAL PROPERTY RIGHTS:**  
 If goods supplied by the Seller to the Buyer's design or specifications infringe or are alleged to infringe any patent or registered design right or copyright the Buyer will indemnify the Seller against all damages, costs and expenses incurred by the Seller as a result of the infringement or allegation. The Buyer will give the Seller all possible help in meeting any infringement claim brought against the Seller.
16. **BUYER'S ERROR IN ORDERING:**  
 In the event the Buyer orders incorrectly the Seller will be under no obligation to the Buyer to rectify or assist in rectifying the error.
17. **LAW AND JURISDICTION:**  
 The contract shall be subject in all respects to English Law and to the jurisdiction of the English Courts.

1 Swaffield Park  
Hyssop Close  
Cannock  
WS11 7FU  
United Kingdom  
T: +44 (0)1543 471680  
[enquiries@durapipe.co.uk](mailto:enquiries@durapipe.co.uk)

