

# Philmac Installer Guide



# Contents

<b>3G Metric™/Imperial</b>	<b>4</b>
Metric/Imperial installation instructions:	
Joiner	8
Slip coupler	9
Reducing kit	10
Normal gauge	11
PE to Copper	12
Metric and imperial kits	13
PVC and ABS connection kit	13
Pipe standards	14
Fittings range	16
Liners and connection kits	27
<b>Universal Transition Couplings (UTC)</b>	<b>30</b>
Principles of operation	33
Fittings range	34
Installation instructions	36
UTC guide	37
<b>EasyLOK Large bore PE metric</b>	<b>38</b>
Installation instructions	39
Fittings range	39
<b>Valves</b>	<b>44</b>
Installation instructions	44
Valve range	46
M.I. connectors suitable for our valves	49
<b>BSP threaded fittings</b>	<b>50</b>
Fittings range	51
Sundries	56
<b>Properties (chemical resistance chart)</b>	<b>59</b>
<b>Adjusta® boundary box</b>	<b>60</b>
Product matrix	61
Product range	62

# Contact us



Tel: +44 (0)330 111 4233

Email: [technical.advice@alixis.com](mailto:technical.advice@alixis.com)

Web: [alixis.co.uk/philmac](http://alixis.co.uk/philmac)



## 3G Metric™ / Imperial

### The complete solution

Patent protected the Metric/Imperial plastic compression fitting is the product of the company's unrelenting commitment to continuous improvement and a culture based on innovation and ingenuity.



### Seven into one will go

Connects:  
 Blue MDPE BS EN12201-2  
 Black MDPE BS EN12201-2  
 Low Density Class C BS 1972  
 Low Density Class D BS 1972  
 High Density Class C BS 3284  
 High Density Class D BS 3284  
 IRS 135 Heavy Gauge BS 1972/61

### No need for inserts or dedicated fittings

When installing on potable water installations, liners must be used with metric pipe sizes 20, 25, 32, 50 and 63mm. No pipe preparation is needed and no force is required to push the pipe past the seal, so installation could not be faster or easier. Simply insert the pipe fully into the fitting and then tighten the nut.

No special tools are required and there is no need to disassemble the fitting before use because the Metric/Imperial compression fitting is supplied pre-assembled and ready to use.

### Materials and components

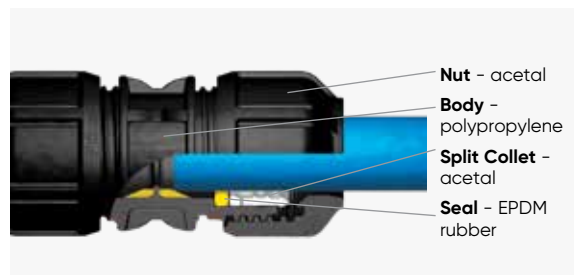

**Long-lasting, corrosion resistant and easy to install, Philmac fittings have proven themselves in irrigation and commercial applications all over the world. They are the fitting choice for both contractors and installers.**



## Fast and easy installation

**Slide and Tighten technology:** 3G compression fittings incorporate all the benefits of Philmac's unique Slide and Tighten technology. No pipe preparation is needed, no force is required to push the pipe past the seal. This means faster and easier installation because the fitting seals on the outside of the pipe. Simply insert the pipe into the fitting until the first point of resistance is felt, and then tighten the nut.

**Compact design:** The size of the Philmac 3G compression fitting has been kept to a minimum, making the fitting ideal for use in confined areas.

**Easy disassembly:** The fitting has been designed so the grip ring is released as soon as the nut is backed off, making disassembly easy.

## Complete security

**Visual stop:** With metric pipe, the body flange on the 3G compression fitting acts as a visual stop to indicate when the nut is tightened. There is no benefit in further tightening of the nut.

**No loose components:** If the nut is removed there is no danger of losing components, as the grip ring and seal ring are retained in the body of the fitting.

**Dynamic sealing method:** As the nut is tightened, the seal is compressed between the pipe and the fitting body.

**Designed to minimise pipe twist:** The fitting has been designed to minimise pipe twist as the nut is tightened. Maximum pipe twist is approximately a quarter turn compared with one and a half turns with many other fittings.

**Approvals:** Philmac 3G compression fittings are WRAS approved for potable water use.



## Lead free

The Philmac range of 3G compression fittings is completely free of lead.

## High performance materials

**Manufactured from engineered materials:** 3G compression fittings are manufactured from lightweight high performance thermoplastic materials that, unlike metal fittings, resist corrosion, significantly minimising maintenance, repairs and long-term costs. The materials are non-toxic and taint-free.

**Pressure rated:** Philmac 3G is pressure rated to 16 bar at 20°C.

## Complete coverage

**Wide range:** The 3G compression fittings range is comprehensive: straight and reducing couplers, tees, elbows, male and female adapters and caps ranging from 1/2" to 2".

## 3G Metric™/Imperial joiner installation instructions

Identify the damaged section and cut away what is needed to be repaired to the appropriate length.



### 1 Cut the pipe square

Cut the pipe square. There is no need to prepare the pipe end. Chamfering or lubrication is not required.



### 2a Insert liner in PE pipe

With PE pipe a liner must be used to ensure conformance with WRAS.



### 2b No liner or insert required for imperial pipe

For connections to imperial PE pipe (BS1972/3284 and IRS 135 heavy gauge) a liner or insert is not required.



### 3 Ready to use

The fitting is pre-assembled and ready to use, however always ensure the nut is fully relaxed and 2 threads are showing before inserting the pipe.



### 4 Pipe insertion

Insert the pipe fully into the fitting to the point where the stop is felt.



### 5 Nut tightening

The nut should be tightened by hand and then firmly with a wrench.



### 6 Fully installed

Fitting is now fully installed.



### 7 Imperial fully installed

For connections to Imperial PE pipe (BS1972/3284 and IRS 135 heavy gauge) steps three to seven are the same as for PE connections.

## Slip coupler installation instructions



Back off nuts on the fitting body until 3 threads are showing.



Lay fitting against pipe with damaged section in the middle of the fitting body. Witness mark against outer edge of nut.



Witness mark against the other outer edge of nut without moving fitting.



Push the fitting on to the pipe.



Push the fitting fully on to the pipe until the pipe goes right through the fitting.



Bring the fitting back up to the pipe and over the damaged section.



Move fitting until it meets the witness mark on both pipes.

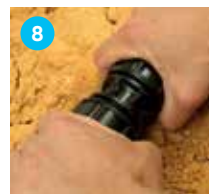

Tighten both nuts by hand.

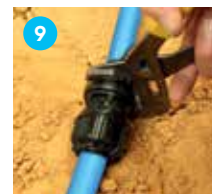

Tighten both nuts fully with a wrench or multi-grips until the nuts meet the flange of the body.



Fitting is fully assembled and damage is repaired.

## Reducing kit installation instructions



Two styles – one for small size reductions (a) and for large size reductions (b)



### Disassembly

Take the Metric/Imperial fitting and remove the nut. Retain this nut for re-installation later.



### Disassembly

The white split collet and seal ring must then be removed. These are no longer required.



### Install reducing kit

Small diameter change kit is illustrated. Take the appropriate connection kit and place it in the body of the fitting with the tapered end pointing outward.



### Install nut

Reinstall the nut. Wind the nut onto body, leaving two threads visible. Pipe is installed as per pipe installation instructions.



### Install reducing kit

Large diameter change kit is illustrated. Take the appropriate connection kit and place it in the body of the fitting as per the image above.



### Install nut

Reinstall the nut. Wind the nut onto body, leaving two threads visible. Pipe is installed as per pipe installation instructions.

## Normal gauge installation instructions

93012	93003	93004	93005	93006	93007
½"	¾"	1"	1-¼"	1-½"	2"
3 part	2 part	3 part	4 part	4 part	2 part
Seal, collet and cap	Seal and collet	Seal, collet and cap	Bodyliner, seal, collet and cap	Bodyliner, seal, collet and cap	Seal and collet



### Remove nut and retain



### Remove collet

This is no longer required.



### Remove seal

This is no longer required.



### Insert NG seal

Marked with red dot for identification.



### Fit collet into body

of fitting. For ½", 1", 1-¼", and 1-½" fit cap on the collet.



### Replace nut

Leave two threads showing.



### Insert pipe

into the fitting to where the stop is felt.



### Tighten by hand

And then firmly with a wrench.

\* can also be used on 3/8" low and high density pipe

### Other sizes

½" Insert one piece adaptor with cap facing out. - 1" seal first followed by collet and cap.

1-¼" and 1-½" Body liner first followed by seal, collet and cap.

# PE to copper installation instructions



3G PE to copper connections incorporates all the benefits of the innovative 3G Metric™/Imperial range, including the patented Slide and Tighten technology. Installation is easier and faster.



## Disassembly

Remove the 3G nut (and keep for reinstallation later), remove the white 3G collet and the black rubber seal.



## Assembly

Check all components are available. Insert the seal into the body, ensuring orientation is correct.



## Assembly

Orientate the stainless steel gripper and plastic backing ring.



## Assembly

Install the 3G Metric/Imperial nut.



## Pipe installation

Cut copper pipe square. Mark the depth of copper insertion using 'pipe stop' marking or body flange as visual indicator. Remove any scale or burrs from the copper pipe.



## Pipe installation

Insert the copper pipe and push into the rubber seal up to the mark indicated.



## Pipe installation

Tighten the nut by hand and finish using a wrench. Remember to check that the nut is tight against the body flange.



## Fully installed

The fitting is now fully installed.

# Metric, imperial, PVC and ABS connection installation instructions

## Metric and imperial kits (excluding 1½" and 2")



## Disassemble

Take the fitting and remove the nut. The white split collet must then be removed and discarded. Ensure the seal remains in the body of the fitting.



## Position the new collet

Take the PVC/ABS collet and place it in the body of the fitting with tapered end pointing outwards.



## Ready to use

Replace the nut on the fitting body which is now ready to use. Connection kit installation instructions now apply.

## Imperial kits 1½" and 2"

### 1 Disassemble

Take the fitting and remove the nut, collet and seal and discard.

### 2 Position the new seal and collet

Take the PVC/ABS collet kit and place the seal in the body of the fitting followed by the collet with the tapered end pointing outward.

### 3 Ready to use

Replace the nut on the fitting body which is now ready to use. Connection kit installation instructions now apply.

## PVC/ABS kits



## Cut the pipe square and remove any burrs.



## Ready to use position

Prior to pipe insertion ensure the nut is fully relaxed with three threads showing.



## Witness mark the pipe

To ensure the correct insertion depth, witness a mark by lining up the pipe against the fitting using the flange of the body as an indicator.



## Pipe insertion

Insert the pipe fully into the fitting upto the witness mark.



## Nut tightening

The nut should be tightened by hand.



## Nut tightening

The nut should then be tightened with a wrench.

# 3G Metric™/Imperial

## Pipe standards

Nominal size	Outside diameter		Wall thickness	
	Min	Max	Min	Max
Inch	mm	mm	mm	mm

### MDPE to Water Industry standard EN 12201, BS 6572 and BS 6730

½	20	20.3	2.3	2.6
¾	25	25.3	2.3	2.6
1	32	32.3	3	3.4
1½	50	50.3	4.6	5.2
2	63	63.3	5.8	6.5

### Class C low density (type 32) polyethylene pipes to BS1972/67

¾	17	17.3	2.2	2.5
½	21.2	21.5	2.7	3
¾	26.6	26.9	3.4	3.7
1	33.4	33.7	4.2	4.6
1¼	42.1	42.5	5.3	5.8
1½	48.1	48.5	6.1	6.7
2	60.1	60.6	7.6	8.4
3	88.6	89.3	11.2	12.3

### Class D low density (type 32) polyethylene pipes to BS1972/67

¾	17	17.3	2.8	3.1
½	21.2	21.5	3.4	3.7
¾	26.6	26.9	4.3	4.7
1	33.4	33.7	5.4	5.9
1¼	42.1	42.5	6.8	7.5
1½	48.1	48.5	7.8	8.6

### Class C high density (type 50) polyethylene pipes to BS3284/67

½	21.2	21.5	1.8	2
¾	26.6	26.9	2.3	2.6
1	33.4	33.7	2.8	3.1
1¼	42.1	42.5	3.6	4
1½	48.1	48.5	4.1	4.5
2	60.1	60.6	5.1	5.6
3	88.6	89.3	7.5	8.2
4	113.9	114.7	9.6	10.6

Nominal size	Outside diameter		Wall thickness	
	Min	Max	Min	Max
Inch	mm	mm	mm	mm

### Class D high density (type 50) polyethylene pipes to BS3284/67

¾	17	17.3	1.9	2.1
½	21.2	21.5	2.3	2.6
¾	26.6	26.9	2.9	3.2
1	33.4	33.7	3.7	4.1
1¼	42.1	42.5	4.6	5.1
1½	48.1	48.5	5.3	5.8
2	60.1	60.6	6.6	7.3
3	88.6	89.3	9.7	10.7

### Normal gauge BS1972/61 IRS 134, see page 28 for product details

½	16.95	17.3	2.3	2.6
¾	24.95	25.4	3.1	3.5
1	31.25	31.75	3.1	3.5
1¼	37.5	38.1	3.1	3.5
1½	43.8	44.45	3.5	3.9
2	60	60.85	4.65	5.2

### Heavy gauge BS1972/61 IRS 135

½	20.7	21.1	4.3	4.85
¾	27.05	27.45	4.3	4.85
1	33.85	34.1	4.3	4.85
1¼	42	42.65	5.05	5.6
1½	47.95	48.65	5.35	5.9



Philmac 3G Metric™ /  
Imperial fittings

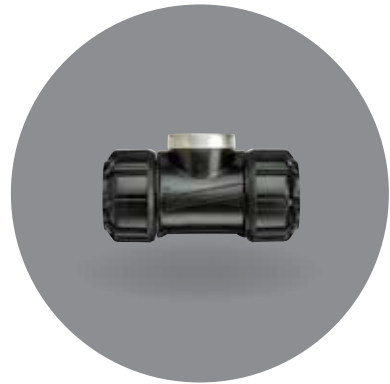

## Compression fittings

### METRIC/IMPERIAL JOINER PE X PE

Part no.	Size	Pcks
9122	20mm/1/2"	10
9133	25mm/3/4"	10
9144	32mm/1"	5
9155	40mm/1 1/4"	1
9166	50mm/1 1/2"	1
9177	63mm/2"	1



### SLIP JOINER METRIC/IMPERIAL JOINER PE X PE – for use in confined spaces

Part no.	Size	Pcks
90122	20mm/1/2"	1
90133	25mm/3/4"	1
90144	32mm/1"	1
90155	40mm/1 1/4"	1
90166	50mm/1 1/2"	1
90177	63mm/2"	1



No internal pipe stop, ideal flexibility for repair or retrofit

### METRIC/IMPERIAL REDUCING JOINER PE X PE

Part no.	Size	Pcks
9132	25mm/3/4" x 20mm/1/2"	10
9142	32mm/1" x 20mm/1/2"	5
9143	32mm/1" x 25mm/3/4"	5
9153	40mm/1 1/4" x 25mm/3/4"	1
9154	40mm/1 1/4" x 32mm/1"	1
9163	50mm/1 1/2" x 25mm/3/4"	1
9164	50mm/1 1/2" x 32mm/1"	1
9165	50mm/1 1/2" x 40mm/1 1/4"	1
9174	63mm/2" x 32mm/1"	1
9175	63mm/2" x 40mm/1 1/4"	1
9176	63mm/2" x 50mm/1 1/2"	1



## Compression fittings

### METRIC/IMPERIAL END CONNECTOR PE X M.I. BSP

Part no.	Size	Pcks
9221	20mm/1/2" x 1/2" BSP	10
9222	20mm/1/2" x 3/4" BSP	10
9223	20mm/1/2" x 1" BSP	10
9231	25mm/3/4" x 1/2" BSP	10
9232	25mm/3/4" x 3/4" BSP	10
9233	25mm/3/4" x 1" BSP	10
9242	32mm/1" x 3/4" BSP	5
9243	32mm/1" x 1" BSP	5
9244	32mm/1" x 1 1/4" BSP	5
9245	32mm/1" x 1 1/2" BSP	5
9253	40mm/1 1/4" x 1" BSP	1
9254	40mm/1 1/4" x 1 1/4" BSP	1
9255	40mm/1 1/4" x 1 1/2" BSP	1
9256	40mm/1 1/4" x 2" BSP	1
9265	50mm/1 1/2" x 1 1/2" BSP	1
9266	50mm/1 1/2" x 2" BSP	1
9275	63mm/2" x 1 1/2" BSP	1
9276	63mm/2" x 2" BSP	1



### METRIC/IMPERIAL END CONNECTOR PE X F.I. BSP

Part no.	Size	Pcks
9821	20mm/1/2" x 1/2" BSP	10
9822	20mm/1/2" x 3/4" BSP	10
9823	20mm/1/2" x 1" BSP	10
9831	25mm/3/4" x 1/2" BSP	10
9832	25mm/3/4" x 3/4" BSP	10
9833	25mm/3/4" x 1" BSP	10
9842	32mm/1" x 3/4" BSP	5
9843	32mm/1" x 1" BSP	5
9844	32mm/1" x 1 1/4" BSP	5
9854	40mm/1 1/4" x 1 1/4" BSP	1
9855	40mm/1 1/4" x 1 1/2" BSP	1
9865	50mm/1 1/2" x 1 1/2" BSP	1
9866	50mm/1 1/2" x 2" BSP	1
9876	63mm/2" x 2" BSP	1



## Compression fittings

### METRIC/IMPERIAL TEE - EQUAL PE X PE

Part no.	Size	Pcks
9322	20mm/1/2"	10
9333	25mm/3/4"	5
9344	32mm/1"	5
9355	40mm/1 1/4"	1
9366	50mm/1 1/2"	1
9377	63mm/2"	1



### SLIP TEE METRIC/IMPERIAL – for use in confined spaces

Part no.	Size	Pcks
90322	20mm/1/2"	1
90333	25mm/3/4"	1
90344	32mm/1"	1
90366	50mm/1 1/2"	1
90377	63mm/2"	1



No internal pipe stop, ideal flexibility for repair or retrofit

### METRIC/IMPERIAL TEE - REDUCING PE X PE

Part no.	Size	Pcks
9332	25mm/3/4" x 25mm/3/4" x 20mm/1/2"	5
9334	25mm/3/4" x 25mm/3/4" x 32mm/1"	5
9343	32mm/1" x 32mm/1" x 25mm/3/4"	5
9363	50mm/1 1/2" x 50mm/1 1/2" x 25mm/3/4"	1
9364	50mm/1 1/2" x 50mm/1 1/2" x 32mm/1"	1
9365	50mm/1 1/2" x 50mm/1 1/2" x 40mm/1 1/4"	1
9373	63mm/2" x 63mm/2" x 25mm/3/4"	1
9374	63mm/2" x 63mm/2" x 32mm/1"	1
9376	63mm/2" x 63mm/2" x 50mm/1 1/2"	1
9175	63mm/2" x 40mm/1 1/4"	1
9176	63mm/2" x 50mm/1 1/2"	1



## Compression fittings

### METRIC/IMPERIAL TEE PE X M.I. BSP

Part no.	Size	Pcks
9931	25mm/3/4" x 1/2" BSP	5
9932	25mm/3/4" x 3/4" BSP	5



### PIPE REPAIR KITS

Part no.	Size	Pcks
PRK20	Pipe repair kit 20mm	3
PRK25	Pipe repair kit 25mm	3
PRK32	Pipe repair kit 32mm	3



### METRIC/IMPERIAL TEE PE X F.I. BSP

Part no.	Size	Pcks
9421	20mm/1/2" x 1/2" BSP	10
9422	20mm/1/2" x 3/4" BSP	10
9431	25mm/3/4" x 1/2" BSP	5
9432	25mm/3/4" x 3/4" BSP	5
9433	25mm/3/4" x 1" BSP	5
9441	32mm/1" x 1 1/2" BSP	5
9442	32mm/1" x 3/4" BSP	5
9443	32mm/1" x 1" BSP	5
9444	32mm/1" x 1 1/4" BSP	5
9454	40mm/1 1/4" x 1 1/4" BSP	1
9455	40mm/1 1/4" x 1 1/2" BSP	1
9461	50mm/1 1/2" x 1 1/2" BSP	1
9462	50mm/1 1/2" x 3/4" BSP	1
9465	50mm/1 1/2" x 1 1/2" BSP	1
9466	50mm/1 1/2" x 2" BSP	1
9476	63mm/2" x 2" BSP	1



## Compression fittings

### METRIC/IMPERIAL ELBOW PE X PE

Part no.	Size	Pcks
9522	20mm/1/2"	10
9533	25mm/3/4"	10
9544	32mm/1"	5
9555	40mm/1 1/4"	1
9566	50mm/1 1/2"	1
9577	63mm/2"	1



### METRIC/IMPERIAL REDUCING ELBOW PE X PE

Part no.	Size	Pcks
9532	25mm/3/4" x 20mm/1/2"	10



### METRIC/IMPERIAL ELBOW PE X F.I. BSP

Part no.	Size	Pcks
9621	20mm/1/2" x 1/2" BSP	10
9622	20mm/1/2" x 3/4" BSP	10
9631	25mm/3/4" x 1/2" BSP	10
9632	25mm/3/4" x 3/4" BSP	10
9633	25mm/3/4" x 1" BSP	10
9642	32mm/1" x 3/4" BSP	5
9643	32mm/1" x 1" BSP	5
9644	32mm/1" x 1 1/4" BSP	5
9654	40mm/1 1/4" x 1 1/4" BSP	1
9655	40mm/1 1/4" x 1 1/2" BSP	1
9665	50mm/1 1/2" x 1 1/2" BSP	1
9666	50mm/1 1/2" x 2" BSP	1
9676	63mm/2" x 2" BSP	1



## Compression fittings

### METRIC/IMPERIAL ELBOW PE X M.I. BSP

Part no.	Size	Pcks
9721	20mm/1/2" x 1/2" BSP	10
9732	25mm/3/4" x 3/4" BSP	10
9743	32mm/1" x 1" BSP	5
9744	32mm/1" x 1 1/4" BSP	5
9753	40mm/1 1/4" x 1" BSP	1
9754	40mm/1 1/4" x 1 1/4" BSP	1
9755	40mm/1 1/4" x 1 1/2" BSP	1
9765	50mm/1 1/2" x 1 1/2" BSP	1
9776	63mm/2" x 2" BSP	1



### METRIC/IMPERIAL 45 DEG ELBOW PE X PE

Part no.	Size	Pcks
9028	20mm/1/2"	1
9038	25mm/3/4"	1
9048	32mm/1"	1
9058	40mm/1 1/4"	1
9068	50mm 1 1/2"	1
9078	63mm 2"	1



### METRIC/IMPERIAL TANK CONNECTOR ASSEMBLY C/W SEAL WASHERS

Part no.	Size	Pcks
9780	25mm/3/4" x 3/4" BSP	10
9781	32mm/1" x 1" BSP	5



Other tank connector options available on pages 53-54.

## Compression fittings

### METRIC/IMPERIAL END CAP

Part no.	Size	Pcks
9029	20mm/1/2"	10
9039	25mm/3/4"	10
9049	32mm/1"	5
9059	40mm/1 1/4"	1
9069	50mm/1 1/2"	1
9079	63mm/2"	1



### METRIC/IMPERIAL WALL PLATE ELBOW PLASTIC

Part no.	Size	Pcks
9022	20mm/1/2" x 1/2" BSP	5
9031	25mm/3/4" x 1/2" BSP	5
9032	25mm/3/4" x 3/4" BSP	5



### METRIC/IMPERIAL WALL PLATE ELBOW METAL

Part no.	Size	Pcks
9228	20mm/1/2" x 1/2" BSP	5
9229	25mm/3/4" x 3/4" BSP	5



### HOSE UNION BIB TAP BS6282 CV

Part no.	Size	Pcks
3022	DZR 1/2" c/w double check valve	1
3033	DZR 3/4" c/w double check valve	1



### ARCTIC ICE RESISTANT BIB TAP

Part no.	Size	Pcks
8021	1/2" BSP	1
8022	3/4" BSP	1
8023	1" BSP *Water: -20°C	1



For Arctic Resistance Ball Valves, see page 45.

## Compression fittings

### HOSE UNION TAP CONNECTOR

Part no.	Size	Pcks
HOSCON 21	1/2"	1
HOSCON 22	3/4" (to suit 8022 only)	1



### METRIC SADDLE

Part no.	Size	Pcks
90635	50mm x 25mm/3/4"	1
90735	63mm x 25mm/3/4"	1



### FLANGE ADAPTOR FLANGE TO BS 4504

Part no.	Size	Pcks
87766	50mm/1 1/2" x 2"	1
87776	63mm/2" x 2"	1



### JOINER - PE X COPPER/PEX PUSH FIT (above ground)\*

Part no.	Size	Pcks
1321	20mm/1/2" x 15mm	1
1331	25mm/3/4" x 15mm	1
1332	25mm/3/4" x 22mm	1
1342	32mm/1" x 22mm	1
1343	32mm/1" x 28mm	1



### ELBOW - PE X COPPER/PEX PUSH FIT (above ground)\*

Part no.	Size	Pcks
1521	20mm/1/2" x 15mm	1
1531	25mm/3/4" x 15mm	1
1532	25mm/3/4" x 22mm	1
2543	32mm/1" x 28mm	1



\* Two part assembled to correct torque, do not tighten further. For connections to PEX pipe please refer to pipe manufacturers installation instructions and only use PEX liners compatible with the pipe being used.

## Compression fittings

### METRIC/IMPERIAL STOPCOCK PE X PE

Part no.	Size	Pcks
2822	20mm/1/2"	5
2833	25mm/3/4"	5
2844	32mm/1"	2



### METRIC/IMPERIAL STOPCOCK PE X FI

Part no.	Size	Pcks
2831	25mm/3/4" x 1/2"	5
2832	25mm/3/4" x 3/4"	5
2842	32mm/1" x 3/4"	2
2843	32mm/1" x 1"	2



### METRIC/IMPERIAL 1/4 TURN BALL VALVE PE X PE

Part no.	Size	Pcks
95272	20mm/1/2" (16mm Nominal Bore)	1
95372	25mm/3/4" (16mm Nominal Bore)	1
95273	25mm/3/4" (19.5mm Nominal Bore)	1
95373	32mm/1" (19.5mm Nominal Bore)	1



Liners to suit PE pipe are required for WRAS requirements, please see page 19 for these items.

## Liners and connection kits

### PE LINERS EN12201/BS 6572 (BELOW GROUND) EN12201/BS 6730 (ABOVE GROUND)

Part no.	Size	Pcks
78002	20mm	100
78003	25mm	100
78004	32mm	50
78006	50mm	25
78007	63mm	20



### METRIC/IMPERIAL CONNECTION KIT

Part no.	Size	Pcks
999002	20mm/1/2"	20
999003	25mm/3/4"	20
999004	32mm/1"	10
999005	40mm/1 1/4"	5
999006	50mm/1 1/2"	5
999007	63mm/2"	5



### METRIC/IMPERIAL REDUCING SETS BS 6572/6730 METRIC BS 1972/3284 AND IRS 135 IMPERIAL

Part no.	Size	Pcks
98032	25mm/3/4" x 20mm/1/2"	10
98042	32mm/1" x 20mm/1/2"	10
98043	32mm/1" x 25mm/3/4"	10
98063	50mm/1 1/2" x 25mm/3/4"	5
98064	50mm/1 1/2" x 32mm/1"	5
98073	63mm/2" x 25mm/3/4"	5
98074	63mm/2" x 32mm/1"	5
98076	63mm/2" x 50mm/1 1/2"	5



## Liners and connection kits

### METRIC/IMPERIAL NORMAL GAUGE CONNECTION KIT BS 1972 IRS 134

Part no.	Size	Pcks
93012	1/2" (fits 3/8" LD and HD)	10
93003	3/4"	10
93004	1"	10
93005	1 1/4"	5
93006	1 1/2"	5
93007	2"	5



### METRIC/IMPERIAL NORMAL GAUGE REDUCING SETS

Part no.	Size	Pcks
93132	3/4" x 1/2"	10
93142	1" x 1/2"	10
93143	1 x 3/4"	10



### METRIC/IMPERIAL COPPER CONNECTION KIT BS EN 1057

Part no.	Size	Pcks
86002	20mm/1/2" x 15mm	10
86003	25mm/3/4" x 22mm	10
86004	32mm/1" x 28mm	10
86032	25mm/3/4" x 15mm	10



Connection Kit for copper pipe for above and below ground use. Suitable for single use only Not suitable for PB or PEX pipe.

See our installation videos on YouTube at Aliaxis UK.

## Liners and connection kits

### METRIC/IMPERIAL BLANKING PLUG

Part no.	Size	Pcks
9128	20mm/1/2"	10
9138	25mm/3/4"	10
9148	32mm/1"	5
9158	40mm/1 1/4"	5
9168	50mm/1 1/2"	5
9178	63mm/2"	5



### METRIC PVC/ABS CONNECTION COLLET

Part no.	Size	Pcks
94202	20mm	10
94203	25mm	10
94204	32mm	10
94205	40mm	1
94206	50mm	1
94207	63mm	1



### IMPERIAL METRIC PVC/ABS CONNECTION COLLET/KIT

Part no.	Size	Pcks
94402	1/2" (20mm/1/2" body)	10
94403	3/4" (25mm/3/4" body)	10
94404	1" (32mm/1" body)	10
94405	1 1/4" (40mm/1 1/4" body)	1
944061	1 1/2" (50mm/1 1/2" body)*	1
944071	2" (63mm/2" body)*	1



\* Complete with nut and seal

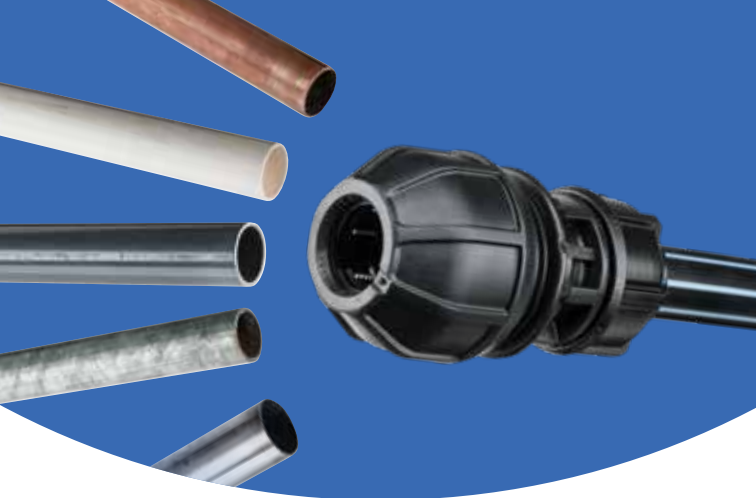

## Universal Transition Coupling - UTC

- Fast and easy installation – Slide and Tighten technology
- Complete security – pre-assembled and no risk of damage to pipes when fitting
- High performance materials – manufactured from advanced thermoplastic engineered materials
- Complete coverage – connecting a wide variety of pipes together including PE, PVC, ABS, copper, stainless steel, galvanised iron and lead.

The UTC is a unique range of mechanical compression fittings that provide the ultimate in pipe connection flexibility.

Our Slide and Tighten technology means no pipe preparation is needed, no force is required to push the pipe past the seal. This means faster installation because the fitting seals on the outside of the pipe.

## The problem solver

Providing complete pipe connection flexibility, the UTC is the first choice for connecting dissimilar pipe materials including PE, PVC, ABS, copper, stainless steel, galvanised iron and lead.

### Fast and easy installation

Slide and Tighten the Philmac UTC incorporates all the benefits of Philmac's Slide and Tighten technology. Simply witness mark the pipe against the flange on the fitting, and then insert the pipe to the correct depth. The nut can then be tightened using a wrench. The UTC is fully installed when the nut can no longer be tightened with reasonable force. No special tools are required and the Philmac UTC is supplied ready to use.

**Easy disassembly:** The design of the UTC means that once the nut is backed off, the pipe can easily be removed from the fitting.

### Complete security

**Visual stop:** The mechanical advantage of the nut thread compresses the seal into position, eliminating resistance when inserting the pipe into the fitting, so there is no risk of seal distortion or displacement.

**No loose components:** The Philmac UTC is pre-assembled and ready to use, there are no loose components. There is no need for individual assembly of a grip ring, sealing ring or nut. All that is required is the insertion of the pipe and tightening of the nut.

**Dielectric (insulating) fitting:** UTC fittings are insulating and are a dielectric fitting for use between dissimilar metals.

**End load resistant:** UTC fittings are fully end load resistant and do not require the use of thrust blocks.

**Approvals:** Philmac UTC fittings are WRAS approved for potable water use.



## High performance materials

**Manufactured from advanced thermoplastic engineered materials:** The Philmac UTC is manufactured from lightweight high performance thermoplastic materials with outstanding impact, UV, chemical and corrosion resistance. The UTC end contains hard stainless steel grippers which provide superior end load resistance.

The Philmac UTC is pressure rated to 12.5 Bar at 20°C to meet the needs of high pressure systems.

## Complete coverage

**Wide range:** The Philmac UTC range is comprehensive: Straight and reducing couplers, elbows and male adaptors, in both transition (PE to UTC) and double ended versions (UTC to UTC) ranging from 15mm to 61mm.

### Connects PE to a wide variety of pipes

PVC, copper, galvanised iron, ABS, lead, stainless steel, steel, polyethylene and PEX

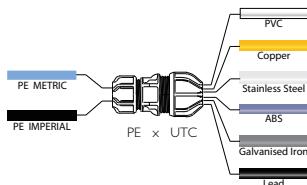

### Connects a wide variety of pipes

PVC, copper, galvanised iron, ABS, lead, stainless steel, steel, polyethylene and PEX\*

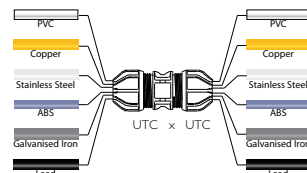

\* Cold water only

## Principals of operation

### Compression fittings

#### Fully open – 3G™ PE end

Fitting is pre-assembled ready to use in the open position with 2 threads showing

Clearance between the pipe and fitting allows for easy insertion of the pipe  
Split collet, which is in relaxed position  
Seal, which is in relaxed position  
The pipe sits against the tapered wedges which minimises pipe rotation

#### Fully open – UTC end

Fitting is pre-assembled in the ready to use position with 3 threads showing

Clearance between the pipe and fitting allows for easy insertion of the pipe  
Split ring – is in a relaxed position  
Seal – is in a relaxed position

#### Fully closed – 3G™ PE end

Split collet bites into the pipe providing end load resistance.

Positive internal stop when nut meets flange of the body.

Nut and then split collet has fully compressed the seal. Seal ring compression is achieved by exploiting the mechanical advantage of the nut thread.

#### Fully closed – UTC end

The nut is tightened with a wrench firmly to ensure proper installation. Some threads may be exposed, depending on the size of pipe inserted into the fitting.

Split ring with the stainless grippers bites into the pipe providing end load resistance

Seal ring compression is achieved by exploiting the mechanical advantage of the thread.

NB:- For the PE 3G end, a liner is required for PE pipe

# UTC installation instructions

Use a pipe measuring gauge if there are doubts on pipe Outside Diameter (OD) size.

Installation instructions are also applicable and available to the PE end.



## 1 Cut pipe to length

Cut pipe square and to length using flange on the central body as a guide. Ensure end of connecting pipe is undamaged and clean.



## 2 Ready to use position

The fitting is pre-assembled and ready to use, however always ensure the nut is backed off and three threads are showing. Pipes at the top of the tolerance may require five threads showing.



## 3 Pipe insertion

To ensure adequate insertion depth, witness mark the pipe to the flange on the fitting. Then insert pipe to the correct depth.



## 4 Nut tightening

Tighten nut firmly with a wrench. Nut will not butt against the body flange when the pipe size is at the top end of the fitting tolerance.



## 5 Fully installed

The fitting is fully installed when the nut cannot be tightened any further with reasonable force.



## 6 Disassembly

Unscrew the nut with a wrench. Pipe will be released and can be pulled out of the fitting.

# UTC Guide

Guide only - Actual size dependant on pipe condition.

UTC range	15-21mm	21-27mm	27-34mm
Pipe circumference	47-66mm	66-85mm	85-107mm
Alkathene	3/8"	1/2"	3/4"
Normal gauge IRS 134	1/2"	3/4"	1"
Heavy gauge IRS 135		1/2"	3/4"
Copper	15mm	22mm	28mm
Galvanised Iron	3/8"	1/2"	3/4"
Stainless steel	3/8"	1/2"	3/4"
Metric ABS/PVC	16mm and 20mm	25mm	32mm
Imperial ABS/PVC	3/8"	1/2"	3/4"
Lead	3/8"	1/2"	3/4"
	5lb (20mm OD)	6lb (21.6mm OD)	9lb (30.6mm OD)
		7lb (23.2mm OD)	11lb (32.8mm OD)
		9lb (25.4mm OD)	
	1/2"	3/4"	1"
	2lb (16mm OD)	4lb (25.2mm OD)	6lb (31mm OD)
	4lb (19.2mm OD)	5lb (26.4mm OD)	7lb (31.6mm OD)

UTC range	34-39mm	39-43mm	47-49mm	59-61mm
Pipe circumference	107-122mm	122-135mm	148-154mm	185-192mm
Alkathene	1"	1 1/4"	1 1/2"	2"
Normal gauge IRS 134	1 1/4"			
Heavy gauge IRS 135	1"			
Copper	35mm	42mm		
Galvanised Iron	1"	1 1/4"	1 1/2"	2"
Stainless steel	1"	1 1/4"	1 1/2"	2"
Metric ABS/PVC		40mm		
Imperial ABS/PVC	1"	1 1/4"	1 1/2"	2"
Lead	1-1"	1 1/4"	1 1/2"	
	7lb (37.6mm OD)	16lb (41mm OD)	12lb (48mm OD)	
		1 1/4"		
		9lb (39.2mm OD)		

Fitting selection can be made easier with a pipe measuring gauge.

**Copper:** For alternative ways to connect to copper other than our UTC system, please contact our Technical Support team on +44 (0) 330 111 4233

**Lead:** The general condition of lead pipe can make sizing difficult at top and bottom tolerance. If the recommended UTC is not successful the next size, up or down, depending on fit should be offered.

## UTC fittings range

### UNIVERSAL TRANSITION JOINER UTC X PE C/W METRIC PE LINER

Part no.	Size	Pcks
1032	15-21mm x 20mm/1/2"	1
1033	15-21mm x 25mm/3/4"	1
1042	21-27mm x 20mm/1/2"	1
1043	21-27mm x 25mm/3/4"	1
1052	27-34mm x 20mm/1/2"	1
1053	27-34mm x 25mm/3/4"	1
1054	27-34mm x 32mm/1"	1
1055	27-34mm x 40mm/1 1/4"	1
1074	34-39mm x 32mm/1"	1
1075	34-39mm x 40mm/1 1/4"	1
1064	39-43mm x 32mm/1"	1
1065	39-43mm x 40mm/1 1/4"	1
1086	47-49mm x 50mm/1 1/2"	1
1087	47-49mm x 63mm/2"	1
1097	59-61mm x 63mm/2"	1



### UNIVERSAL TRANSITION ELBOW UTC X PE C/W METRIC PE LINER

Part no.	Size	Pcks
1533	15-21mm x 25mm/3/4"	1
1543	21-27mm x 25mm/3/4"	1
1544	21-27mm x 32mm/1"	1
1553	27-34mm x 25mm/3/4"	1
1653	27-34mm x 32mm/1"	1



### UNIVERSAL TRANSITION DOUBLE ENDED REPAIR JOINER

Part no.	Size	Pcks
1133	15-21mm x 15-21mm	1
1144	21-27mm x 21-27mm	1
1155	27-34mm x 27-34mm	1
1177	34-39mm x 34-39mm	1
1166	39-43mm x 39-43mm	1
1188	47-49mm x 47-49mm	1
1199	59-61mm x 59-61mm	1



## UTC fittings range

### UNIVERSAL TRANSITION REDUCED REPAIR JOINER

Part no.	Size	Pcks
1143	21-27mm x 15-21mm	1
1154	27-34mm x 21-27mm	1
1153	27-34mm x 15-21mm	1
1165	39-43mm x 27-34mm	1



### UNIVERSAL TRANSITION M.I. END CONNECTOR UTC X M.I. BSP

Part no.	Size	Pcks
1231	15-21mm x 1/2" BSP	1
1232	15-21mm x 3/4" BSP	1
1233	15-21mm x 1" BSP	1
1242	21-27mm x 3/4" BSP	1
1243	21-27mm x 1" BSP	1
1244	21-27mm x 1 1/4" BSP	1
1252	27-34mm x 3/4" BSP	1
1253	27-34mm x 1" BSP	1
1254	27-34mm x 1 1/4" BSP	1
1255	27-34mm x 1 1/2" BSP	1





## EasyLOK Large bore PE metric

### Easy and reliable assembly

EasyLOK fittings are designed to make installation reliable and as easy as possible. The components easily fit onto the pipe and ensure that everything is positioned correctly, no matter the condition of the pipe. The pipe can then be pushed into the body of fitting and the nut fully tightened to create a reliable seal.

### Easy disassembly for re-use

EasyLOK fittings can be re-used, if necessary. Simply loosen the nut, release the internal components and pipe from the fitting. Disassembly could not be easier.

### Fail-safe with minimum torque

The flange on the body of the EasyLOK fitting provides a visual stop to indicate when the nut is fully tightened, removing any uncertainty from the installation process. It is essential that the nut is tightened fully so that no threads are showing to ensure complete compression of the seal. The EasyLOK range has been designed to minimise the torque required to tighten the nut, making installation as simple and easy as possible.

### Impact resistance

With an ever present risk of impact, fittings must be tough and durable to stand the test of time. EasyLOK fittings are made from a high-grade polypropylene which provides significant resistance to impact, making it a long-lasting solution.

### Chemical resistance

Standard compression fittings are supplied with nitrile seals which fail when they come into contact with acids. EasyLOK fittings are supplied with EPDM seals which means that the fittings can withstand a wide range of chemicals without having to switch components.

# EasyLOK large bore

## Assembly



### Cut the pipe

Cut the pipe square. There is no need to chamfer or lubricate the pipe.



### Remove the nut

Take the fitting apart, remove the nut.



### Remove remaining components

Remove the split ring, collet and O-ring.



### Fit all components onto pipe

Slide the components onto the pipe, first the nut, then the split ring and collet followed by the O-ring.



### Insert pipe

Insert the pipe into the fitting body ensuring pipe butts against tapered wedges in body of fitting. Bring the components up to the fitting body.



### Hand tighten

Tighten the nut by hand.



### Tighten with tool

While holding the body tighten the nut all the way to the flange using multi-grips.

## Disassembly



### Loosen the nut

Use the multi-grips to loosen the nut then continue to loosen by hand and slide the body off the pipe.



### Disassemble

Remove the O-ring, then the split ring, collet and nut, then re-assemble the fitting and it is now ready to re-use.

## EasyLOK fittings range

### JOINER PE X PE

Part no.	Size	Pcks
97 6188 00	75mm	1
97 6199 00	90mm	1
97 6100 00	110mm	1



### REDUCING JOINER

Part no.	Size	Pcks
97 6187 00	75mm x 63mm	1
97 6198 00	90mm x 75mm	1
97 6109 00	110mm x 90mm	1



### METRIC SLIP JOINER PE X PE

Part no.	Size	Pcks
97 6018 80	75mm	1
97 6019 90	90mm	1
97 6010 00	110mm	1



## EasyLOK fittings range

### END CONNECTOR PE X M.I. BSP

Part no.	Size	Pcks
97 6286 00	75mm x 2" BSP	1
97 6288 00	75mm x 3" BSP	1
97 6298 00	90mm x 3" BSP	1
97 6209 00	110mm x 4" BSP	1



### TEE - EQUAL PE X PE

Part no.	Size	Pcks
97 6388 00	75mm	1
97 6399 00	90mm	1
97 6300 00	110mm	1



### TEE - EQUAL PE X F.I. BSP

Part no.	Size	Pcks
97 6486 00	75mm x 2" BSP	1
97 6498 00	90mm x 3" BSP	1
97 6409 00	110mm x 4" BSP	1



### ELBOW PE X PE

Part no.	Size	Pcks
97 6588 00	75mm	1
97 6599 00	90mm	1
97 6500 00	110mm	1



## EasyLOK fittings range

### ELBOW PE X F.I. BSP

Part no.	Size	Pcks
97 6686 00	75mm x 2" BSP	1
97 6698 00	90mm x 3" BSP	1
97 6609 00	110mm x 4" BSP	1



### END CAP

Part no.	Size	Pcks
97 6089 00	75mm	1
97 6099 00	90mm	1
97 6009 00	110mm	1



### FLANGE ADAPTOR - FLANGE TO BS 4504

Part no.	Size	Pcks
97 6998 00	90mm x 3"	1
97 6909 00	110mm x 4"	1





## Valves

### Fast and easy installation

**Threaded or compression inlet/outlet:** The different options allow compatibility with existing installations and keeps installation time to a minimum.

**Slide and Tighten™ technology:** Compression ends incorporate all the benefits of Philmac's unique technology, which means no force is required to push the pipe past the seal. Simply insert the pipe fully into the fitting and tighten the nut.

**Bi-directional flow:** The ball valves have been designed to work in either direction to ensure easy installation and eliminate the need to look for identification marks.

**Multi-position installation:** The valves can be installed in any orientation to assist with all types of installations.

### Complete Security

**Reliable operation:** High-quality injection moulded components and polypropylene ball means years of reliable operation.

**Corrosion resistant:** With a plastic body and components, plus rubber O-rings and a stainless steel handle screw, the components used have a high degree of corrosion resistance.

**Positive open-close:** Rotate through 90° between fully open and fully closed to ensure there is no guesswork required as to whether it is open or closed.

### Lead free

The Philmac range of ball valves is completely free from lead.

**Long-lasting, corrosion resistant and easy to install, Philmac fittings have proven themselves in irrigation and commercial applications all over the world. They are the fitting choice for both contractors and installers.**



### High performance materials

Manufactured from engineered materials: Philmac valves are manufactured from lightweight, high performance thermoplastic materials that have excellent impact, UV and corrosion resistance. The materials are non-toxic and taint free.

## ✓ Complete coverage

- Pressure rated 14 bar
- Can be installed above or below ground
- Complete range: agriculture, municipal, corrosion resistance, long life performance
- Manufactured with thermoplastic materials – UV resistant qualities
- ¼ Turn for visual on/off control



## Installation instructions



### Preparation

Apply PTFE tape or approved sealant to the male thread. Sufficient tape needs to be applied to ensure a watertight seal.



### Assembly

Screw on to a male or female thread by hand until firm.



### Tighten

Using a pipe wrench or multigrips on the end caps only, further screw the ball valve tight. Where necessary, ensure the thread is held stationary to avoid it from moving. Do not use pipe wrench or multigrips on the body of the valve.

## Valves range

### METRIC/IMPERIAL STOPCOCK PE X PE

Part no.	Sizes	Nominal Bore	Pcks
2822	20mm/½"	-	5
2833	25mm/¾"	-	5
2844	32mm/1"	-	2



## Valves range

### METRIC/IMPERIAL STOPCOCK PE X FI

Part no.	Sizes	Nominal Bore	Pcks
2831	25mm/¾" x ½"	-	5
2832	25mm/¾" x ¾"	-	5
2842	32mm/1" x ¾"	-	2
2843	32mm/1" x 1"	-	2



### METRIC/IMPERIAL ¼ TURN BALL VALVE PE X PE

Part no.	Sizes	Nominal Bore	Pcks
95272	20mm/½"	16	1
95372	25mm/¾"	16	1
95273	25mm/¾"	19.5	1
95373	32mm/1"	19.5	1



### ARCTIC ICE RESISTANT BALL VALVE

Part no.	Sizes	Nominal Bore	Pcks
8031	½"	15	1
8032	¾"	20	1
8033	1"	25	1



### BALL VALVE F.I. X F.I. BSP

Part no.	Sizes	Nominal Bore	Pcks
55002	¾" F.I. x ¾" F.I.	16	1
55003	1" F.I. x 1" F.I.	19.5	1
55004	1¼" F.I. x 1¼" F.I.	26	1
55005	1½" F.I. x 1½" F.I.	32	1
55006	2" F.I. x 2" F.I.	40	1



### BALL VALVE M.I. X M.I. BSP

Part no.	Sizes	Nominal Bore	Pcks
55402	¾" M.I. x ¾" M.I.	16	1
55403	1" M.I. x 1" M.I.	19.5	1





## Back flow prevention and metal valve range

### AIR RELEASE VALVE M.I. BSP

Part no.	Sizes	Nominal Bore	Pcks
93109	1" BSP	-	1



### FOOT VALVE F.I. BSP

Part no.	Sizes	Nominal Bore	Pcks
58012	¾" BSP	22	1
58013	1" BSP	27	1
58014	1¼" BSP	32	1
58015	1½" BSP	38	1
58016	2" BSP	50	



### SINGLE CHECK NON RETURN VALVE F.I. BSP X F.I. BSP

Part no.	Sizes	Nominal Bore	Pcks
58022	¾" F.I. x ¾" F.I.	22	1
58023	1" F.I. x 1" F.I.	27	1
58024	1¼" F.I. x 1¼" F.I.	32	1
58025	1½" F.I. x 1½" F.I.	38	1
58026	2" F.I. x 2" F.I.	50	1



### DZR DOUBLE CHECK VALVE F.I. BSP X F.I. BSP TO BS 6282 BACK FLOW PREVENTION CATEGORY 3

Part no.	Sizes	Nominal Bore	Pcks
11101	½" F.I. x ½" F.I.	15	1
11202	¾" F.I. x ¾" F.I.	20	1
11303	1" F.I. x 1" F.I.	25	1



### GM FI X FI STOPCOCK (BS.5433 TYPE20)

Part no.	Sizes	Nominal Bore	Pcks
2511	½" x ½" F.I.		1
2522	¾" x ¾" F.I.		1
2533	1" x 1" F.I.		1
2055	1½" x 1½" F.I.		1
2066	2" x 2" F.I.		



## Metric/Imperial BSP end connectors (for above valves)

### METRIC/IMPERIAL END CONNECTOR PE X M.I. BSP

Part no.	Size	Pcks
9221	20mm/½" x ½" BSP	10
9222	20mm/½" x ¾" BSP	10
9223	20mm/½" x 1" BSP	10
9231	25mm/¾" x ½" BSP	10
9232	25mm/¾" x ¾" BSP	10
9233	25mm/¾" x 1" BSP	10
9242	32mm/1" x ¾" BSP	5
9243	32mm/1" x 1" BSP	5
9244	32mm/1" x 1¼" BSP	5
9245	32mm/1" x 1½" BSP	5
9253	40mm/1¼" x 1" BSP	1
9254	40mm/1¼" x 1¼" BSP	1
9255	40mm/1¼" x 1½" BSP	1
9256	40mm/1¼" x 2" BSP	1
9265	50mm/1½" x 1½" BSP	1
9266	50mm/1½" x 2" BSP	1
9275	63mm/2" x 1½" BSP	1
9276	63mm/2" x 2" BSP	1



Liners to suit PE pipe are required for WRAS requirements, please see page 27 for these items

### METRIC/IMPERIAL END CONNECTOR PE X F.I. BSP

Part no.	Size	Pcks
9823	20mm/½" x 1" BSP	10
9833	25mm/¾" x 1" BSP	10
9843	32mm/1" x 1" BSP	5





## BSP threaded fittings

A tough, corrosion resistant range of fittings to meet BSP thread Standards

### ✓ Complete coverage

- BSP tapered threads
- Fully comprehensive range
- Complements plastic pipelines
- Robust threaded fittings
- Maximises sealing performance
- Corrosion resistant
- Versatile range
- High performance UV resistant materials (polypropylene)
- Quick and simple to install
- Reliable installation
- ½" to 2" products are able to operate at 16 Bar

### Ⓟ Lead free

The Philmac range of threaded fittings is completely free from lead.

## BSP threaded fittings range

### TEE FEMALE

Part no.	Size	Pcks
4511	½" BSP	10
4522	¾" BSP	10
4533	1" BSP	10
4544	1¼" BSP	5
4555	1½" BSP	5
4566	2" BSP	2



### ELBOW FEMALE

Part no.	Size	Pcks
4611	½" BSP	10
4622	¾" BSP	10
4633	1" BSP	10
4644	1¼" BSP	5
4655	1½" BSP	5
4666	2" BSP	2



### ELBOW MALE X FEMALE

Part no.	Size	Pcks
4691	½" x ½" BSP	10
4692	¾" x ¾" BSP	10
4693	1" x 1" BSP	10
4694	1¼" x 1¼" BSP	5
4695	1½" x 1½" BSP	5
4696	2" x 2" BSP	2



### PLUG

Part no.	Size	Pcks
4011	½" BSP	10
4022	¾" BSP	10
4033	1" BSP	10
4044	1¼" BSP	10
4055	1½" BSP	10
4066	2" BSP	10



## BSP threaded fittings range

### BUSH REDUCING

Part no.	Size	Pcks
4121	¾" x ½" BSP	10
4131	1" x ½" BSP	10
4132	1" x ¾" BSP	10
4141	1¼" x ½" BSP	10
4142	1¼" x ¾" BSP	10
4143	1¼" x 1" BSP	10
4151	1½" x ½" BSP	10
4152	1½" x ¾" BSP	10
4153	1½" x 1" BSP	10
4154	1½" x 1¼" BSP	10
4161	2" x ½" BSP	10
4162	2" x ¾" BSP	10
4163	2" x 1" BSP	10
4164	2" x 1¼" BSP	10
4165	2" x 1½" BSP	10
4186	3" x 2" BSP	1
4198	4" x 3" BSP	1



### NIPPLE

Part no.	Size	Pcks
4211	½" BSP	10
4222	¾" BSP	10
4233	1" BSP	10
4244	1¼" BSP	5
4255	1½" BSP	5
4266	2" BSP	5



### SOCKET

Part no.	Size	Pcks
4311	½" BSP	10
4322	¾" BSP	10
4333	1" BSP	10
4344	1¼" BSP	5
4355	1½" BSP	5
4366	2" BSP	5



## BSP threaded fittings range

### NIPPLE – REDUCING

Part no.	Size	Pcks
4221	¾" x ½" BSP	10
4231	1" x ½" BSP	10
4232	1" x ¾" BSP	10
4241	1¼" x ½" BSP	5
4242	1¼" x ¾" BSP	5
4243	1¼" x 1" BSP	5
4251	1½" x ½" BSP	5
4252	1½" x ¾" BSP	5
4253	1½" x 1" BSP	5
4254	1½" x 1¼" BSP	5
4261	2" x ½" BSP	5
4262	2" x ¾" BSP	5
4263	2" x 1" BSP	5
4264	2" x 1¼" BSP	5
4265	2" x 1½" BSP	5
4186	3" x 2" BSP	1
4198	4" x 3" BSP	1



### REDUCING SOCKET

Part no.	Size	Pcks
4321	¾" x ½" BSP	10
4331	1" x ½" BSP	10
4332	1" x ¾" BSP	5
4343	1¼" x 1" BSP	5
4352	1½" x ¾" BSP	5
4353	1½" x 1" BSP	5
4354	1½" x 1¼" BSP	5
4362	2" x ¾" BSP	5
4363	2" x 1" BSP	5
4365	2" x 1½" BSP	5



## BSP threaded fittings range

### CAP

Part no.	Size	Pcks
4901	1/2" BSP	10
4902	3/4" BSP	10
4903	1" BSP	10
4904	1 1/4" BSP	5
4905	1 1/2" BSP	5
4906	2" BSP	5



### M.I. BSP HOSE TAILS

Part no.	Size	Pcks
RXHT15	1/2" BSP	10
RXHT20	3/4" BSP	10
RXHT25	1" BSP	10
RXHT32	1 1/4" BSP	10
RXHT40	1 1/2" BSP	10
RXHT50	2" BSP	5



### IBC SWIVEL-IT ADAPTORS

Part no.	Size	Pcks
60UD075B	2" x 3/4" F.I. BSP	1
60UD10B	2" x 1" F.I. BSP	1
60UD20B	2" x 2" F.I. BSP	1



N.B. All threads are BSP tapered. Use PTFE tape on threads for lubrication purposes. Do not overtighten.

### MALE THREADED TANK CONNECTOR WITH FEMALE INLET

Part no.	Size	Pcks
RXTTI15	1/2" BSP	1
RXTTI20	3/4" BSP	1
RXTTI25	1" BSP	1
RXTTI32	1 1/4" BSP	1
RXTTI40	1 1/2" BSP	1
RXTTI50	2" BSP	1



## BSP threaded fittings range

### CUT TO SIZE TANK CONNECTOR KITS (PVC)

Part no.	Size	Pcks
TCK050	1/2" BSP	1
TCK075	3/4" BSP	1
TCK100	1" BSP	1



Containing long thread (1 ft long), backnuts (2) and a washer

## Sundries

### HIGH FLOW BALLCOCK

Part no.	Size	Pcks
RXPTV20	3/4" standard thread 25mm tail	1
RXPTV20L	3/4" long thread 45mm tail c/w nut	1
70221	3/4" Float Valve 165mm lever Long thread	1



### PIPE CUTTER

Part no.	Size	Pcks
1769	Up to 32mm (medium)	1
1770	Up to 63mm (large)	1



### SPANNER

Part no.	Size	Pcks
702431	20 - 32mm 'Y' spanner (plastic)	1
7024	20-32mm 'Y' spanner (metal)	1
7047	32-63mm 'C' spanner	1
7057	40 - 63mm 'Y' spanner	1
7050	50 - 110mm 'C' spanner	1



## Sundries

### PIPE CLIPS – Suitable for PE pipe

Part no.	Size	Pcks
4305	16mm (oc)	10
4306	20mm (oc)	10
4307	25mm (oc)	10
4308	32mm (cc)	10
4309	40mm (cc)	10
4310	50mm (cc)	10
4312	63mm (cc)	10
4313	90mm (cc)	10
4314	110mm (cc)	10

(oc) openclip (cc) closedclip



### SQUEEZE OFF TOOLS

Part no.	Size	Pcks
MINI2032	20-32mm	1
MIDI2063	20-63mm	1



### PIPE REPAIR KITS

Part no.	Size	Pcks
PRK20	Pipe repair kit 20mm	3
PRK25	Pipe repair kit 25mm	3
PRK32	Pipe repair kit 32mm	3



## High performance materials

### Fluids other than Water

Pipes connected by Philmac may convey a wide variety of fluids. For resistance to common chemicals consider the table on page 59 as a guide only.

### Specific applications

Please contact our experts for for technical advice and support. **Telephone: +44 (0) 330 111 4233**

### Dynamic sealing method

The mechanical advantage of the nut thread compresses the seal into position, eliminating resistance when inserting the pipe into the fitting so there is no risk of seal distortion or displacement.

### No loose components

If the nut is removed there is no danger of losing components, as the collet and seal ring are retained in the body of the fitting. Losing components in the trench becomes a thing of the past.

### Designed to minimise pipe twist

The fitting has been designed to minimise pipe twist as the nut is tightened. Maximum pipe twist is approximately a quarter turn compared to one and a half turns with many other fittings. Pipe twist can impact on not only the connection you have just made but also on the connection at the other end of the line.

### Made from advanced thermoplastic materials

3G Metric/Imperial is manufactured from lightweight high performance thermoplastic materials with outstanding impact, UV, chemical and corrosion resistance. The material is non-toxic and taint-free.

### Rated to 16 bar

Metric/Imperial is pressure rated to 16 Bar (230psi) to meet the needs of high pressure systems.

**50 year+ design life:** Built to withstand the toughest conditions to ensure longevity and durability, Metric/Imperial has a 50 year+ design life.

### Complete coverage

#### Wide range

The Philmac 3G Metric/Imperial range is comprehensive: straight and reducing joiners, tees, elbows, end connectors and caps ranging from 20mm to 63mm. Also available are copper connection kits, normal gauge (IRS 134) connection kits, reducing kits and blanking plugs, ball valves, stopcocks, wall plate elbows and tank connectors.

#### Effect on water

Philmac does not impart to water any odour, taste, colour, or any constituents in concentrations that could be injurious to health.

#### Philmac complies with

BS 6920: 'Suitability of non-metallic products for use in contact with potable water intended for human consumption with regard to their effect on the water'.

#### Operating Temperatures

-10°C to +25°C: Not suitable for hot water applications.

Chemical resistance chart		
Chemical	Satisfactory	Not satisfactory
Acetone		✗
Alcohol	✓	
Ammonium hydroxide	✓	
Antifreeze	✓	
Benzene		✗
Butane	✓	
Calcium salts	✓	
Caustic soda (40% aqueous)	✓	
Chlorine	✓	
Citric acid (10% aqueous)	✓	
Copper salts	✓	
Cresol		✗
Ethylene alcohol	✓	
Ethyl glycol	✓	
Diesel	✓	
Formic acid		✗
Gasoline		✗
Hydrochloric acid		✗
Kerosene		✗
Methane	✓	
Methylene chloride		✗
Mineral oils	✓	
Nitric acid		✗
Petroleum oil	✓	
Sewerage	✓	
Sodium cyanide	✓	
Sulphuric acid		✗
Toluene		✗
Turpentine		✗
Transformer oil	✓	
Zinc salt solution	✓	



# Adjusta<sup>®</sup> boundary box

The only load-bearing adjustable boundary box

Designed to house the meter at the boundary between the water main and the domestic supply, the comprehensive range of Adjusta boundary boxes have been developed with complete flexibility in mind.

Adjusta boundary boxes are manufactured with an adjustable top section, enabling the installer to easily adjust the height of and pitch of the boundary box to suit the specific on-site conditions without compromising on loading capacity.

For installation support please visit [alixis.co.uk](http://alixis.co.uk)  
or speak to our Technical Support Team on  
+44 (0) 330 111 4233

## Product matrix

### Lids



### Bases



### Connections



## Contaminated land

### CONTAMINATED LAND BOX (SEALED)

Part no.	Height		Tether	Base	Other
	Min (mm)	Max (mm)			
LUBA0007	650	870	None	Standard	-
LUBA1000	650	870	Tether	Standard	-
LUBA1043	650	870	None	Standard	-
LUBA1048	650	940	None	Standard	Tethered surface box assembly
LUBA1039	695	985	None	Standard	-



### ADJUSTA BRASS MANIFOLD (UNSEALED)

Part no.	Height		Lid	Tether	Base	Other
	Min (mm)	Max (mm)				
LUBA1052	580	790	None	None	Standard	-
LUBA1068	580	790	Water	None	Standard	-
LUBA1075	580	860	Water	None	Drain	Tethered surface box assembly



### RIGID BRASS MANIFOLD (UNSEALED)

Part no.	Height fixed (mm)	Tether	Base
LUBA1066	682	None	Standard



## Rigid box

### RIGID BOX (TAILS)

Part no.	Height fixed (mm)	Lid	Tether	Base
LUBA0012	682	None	None	Standard
LUBA0089	868	None	None	Standard



### RIGID PUSH FIT BOX

Part no.	Height fixed (mm)	Lid	Tether	Base	Other
LUBA0109	682	None	None	Standard	-
LUBA1041	752	Water	Water	Standard	Surface box assembly





## Adjusta box

### ADJUSTA BOUNDARY BOX (TAILS)

Part no.	Height		Lid	Tether	Base	Other
	Min (mm)	Max (mm)				
LUBA0045	580	790	None	None	Standard	-
LUBA1002	580	790	Water	Tether	Drain	-
LUBA1006	580	790	Water	None	Standard	-
LUBA1047	580	860	Water	Tether	Drain	BA1046 + Surface box
LUBA0092	440	590	None	None	Standard	Mini Adjusta
LUBA1001	440	590	Water	Tether	Drain	Mini Adjusta
LUBA1007	440	590	Water	None	Standard	Mini Adjusta
LUBA1049	440	660	Water	Tether	Drain	Mini Adjusta + Sq Surface box



### ADJUSTA GUARD TUBE ASSEMBLY

Part no.	Height fixed (mm)	Lid	Base
LUBA1022	650	None	Split Base BM1017
LUBA1024	593	None	



### CHAMBER

Part no.	Height fixed (mm)	Lid	Base	Other
LUBA1027	370	None	No fins BM0120	BA1027 + lid assembly



## Adjusta box

### ADJUSTA PUSH FIT BOX

Part no.	Height		Lid	Tether	Base	Other
	Min (mm)	Max (mm)				
LUBA0099	580	790	None	None	Standard	25mm elbow
LUBA0100	580	790	Water	Tether	Standard	20mm elbow
LUBA1037	580	860	Water	Tether	Drain	Surface box assembly
LUBA1038	440	660	Water	None	Drain	Mini Adjusta/surface box assembly
LUBA1028	440	590	Water	None	Standard	Mini Adjusta
LUBA1040	580	790	Water	Tether	Standard	-
LUBA1044	440	590	Water	None	Standard	Mini Adjusta
LUBA1045	580	790	Water	None	Standard	-
LUBA1082	580	790	Water	Tether	-	Outlet tail



### ADJUSTA ACCESSORIES

Part no.	Height fixed (mm)	Lid	Tether	Other
LUBA1035	370	Water	Tether	Top Section Only
LUBA1080	280	Water	Tether	Adjusta Tube/Tethered surface box assembly
LUBA1071	440	Water	Tether	Top Section Only/
LUBA1081	440	Water/No keyhole	Tether	Tethered surface box assembly



## Miscellaneous

### SQUARE COWL

Part no.

LUBA1073



### SURFACE BOX

Part no.	Lid	Tether	Other
LUBA0043	None	None	-
LUBA0056	Water	None	Lid/Plate assembly with keyhole
LUBA1036	Water	Tether	Lid/Plate assembly with keyhole
LUBA0115	Water	None	Location disc



### SLOPE ADJUSTA

Part no.

LUBA0018



### CORRUGATED GUARD TUBE ASSEMBLY

Part no.

LUBA0039



### MANIFOLD ASSEMBLY

Part no.

LUBA0016

LUBA1067



## Miscellaneous

### TAP ASSEMBLY

Part no.

LUBA0036



### BLANKING CAP + O-RING

Part no.

LUBA0037



### MANIFOLD PLUG NO FLOW KIT

Part no.

LUBA0046



### MANIFOLD PLUG AND O-RING KIT

Part no.

LUBA0047



### MANIFOLD PLUG TRICKLE FLOW KIT

Part no.

LUBA0048



## Miscellaneous

### NRV ASSEMBLY

Part no.

LUBA0084



### DCV ASSEMBLY

Part no.

LUBA1076



### ADJUSTA BOX FROST PLUG (185mm)

Part no.

LUBM0123



### RIGID BOX FROST PLUG (195mm)

Part no.

LUBM0055



## Field tools

### ADJUSTA LID LIFTING TOOL FOR KEYHOLE

Part no.

LUBM1004



### ADJUSTA LID LIFTING TOOL NONE KEYHOLE

Part no.

LUBM1003



### PUSH FIT CONNECTOR TOOL

Part no.

LUBM1036



### HEIGHT ADJUSTMENT TOOL 'ADJUSTA'

Part no.

LUBM0093



### OUTER SLEEVE ASSY TOOL

Part no.

LUBM1058



### NUT TOOL STOP TAP

Part no.

LUBM1059





Aliaxis UK  
Dickley Lane  
Lenham  
Maidstone  
Kent  
ME17 2DE  
United Kingdom  
+44 (0) 330 111 4233  
orders@aliaxis.com

[aliaxis.co.uk/philmac](http://aliaxis.co.uk/philmac)

